

ROBERTS

Sound for Generations

RP16

3 Band Mains Battery
Preset FM Portable Radio

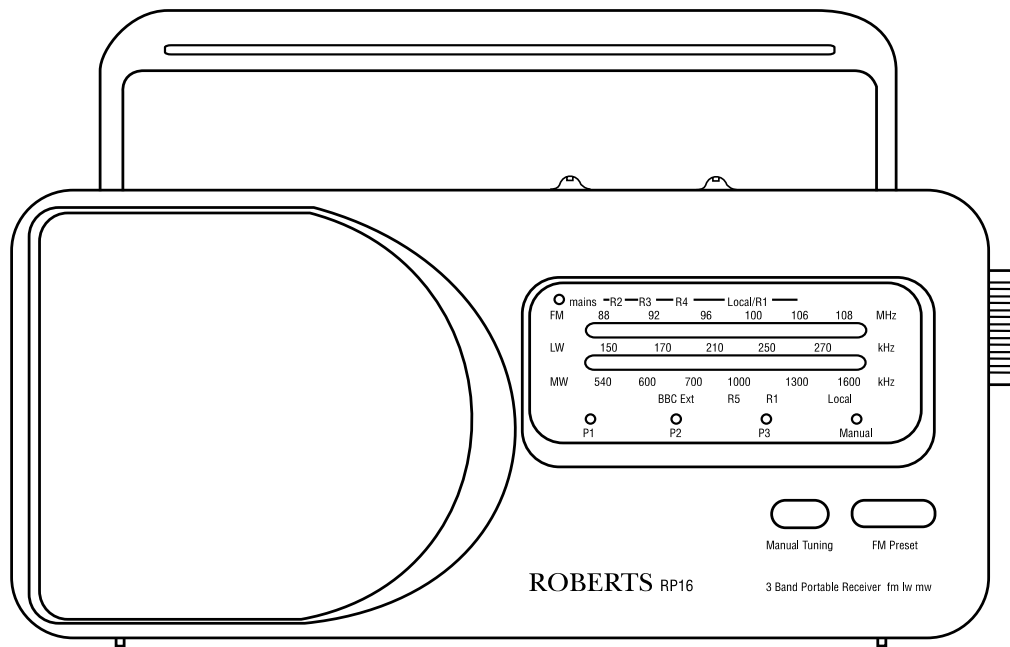

Please read this manual before use

Controls

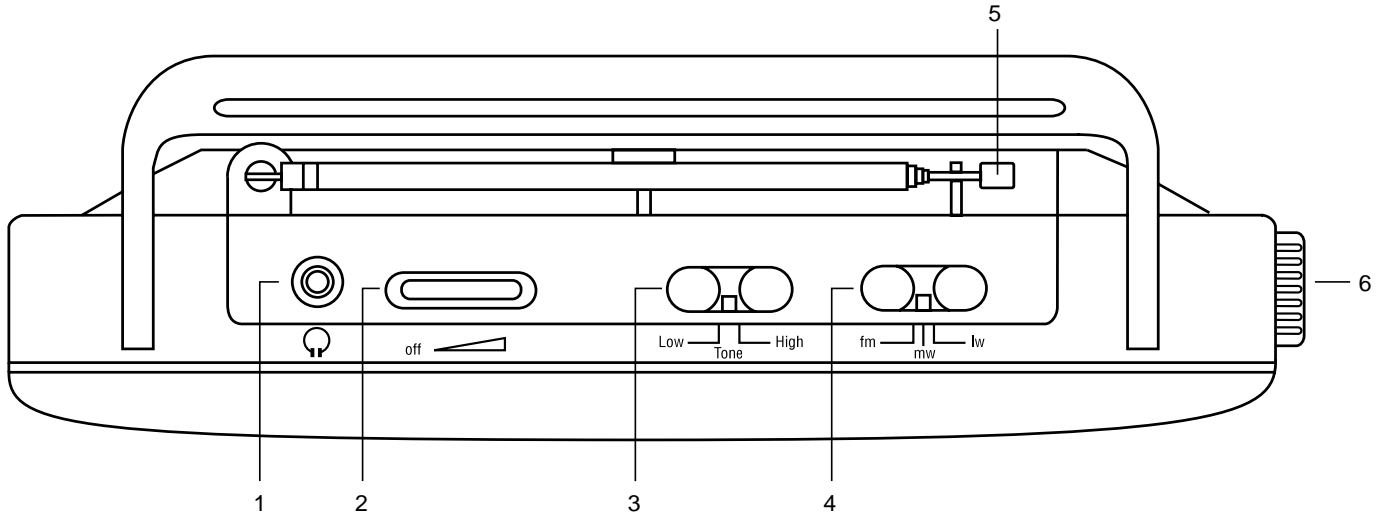

1. Headphone socket
2. Volume control
3. Tone control

4. Waveband switch
5. Telescopic aerial
6. Tuning knob

Controls (cont.)

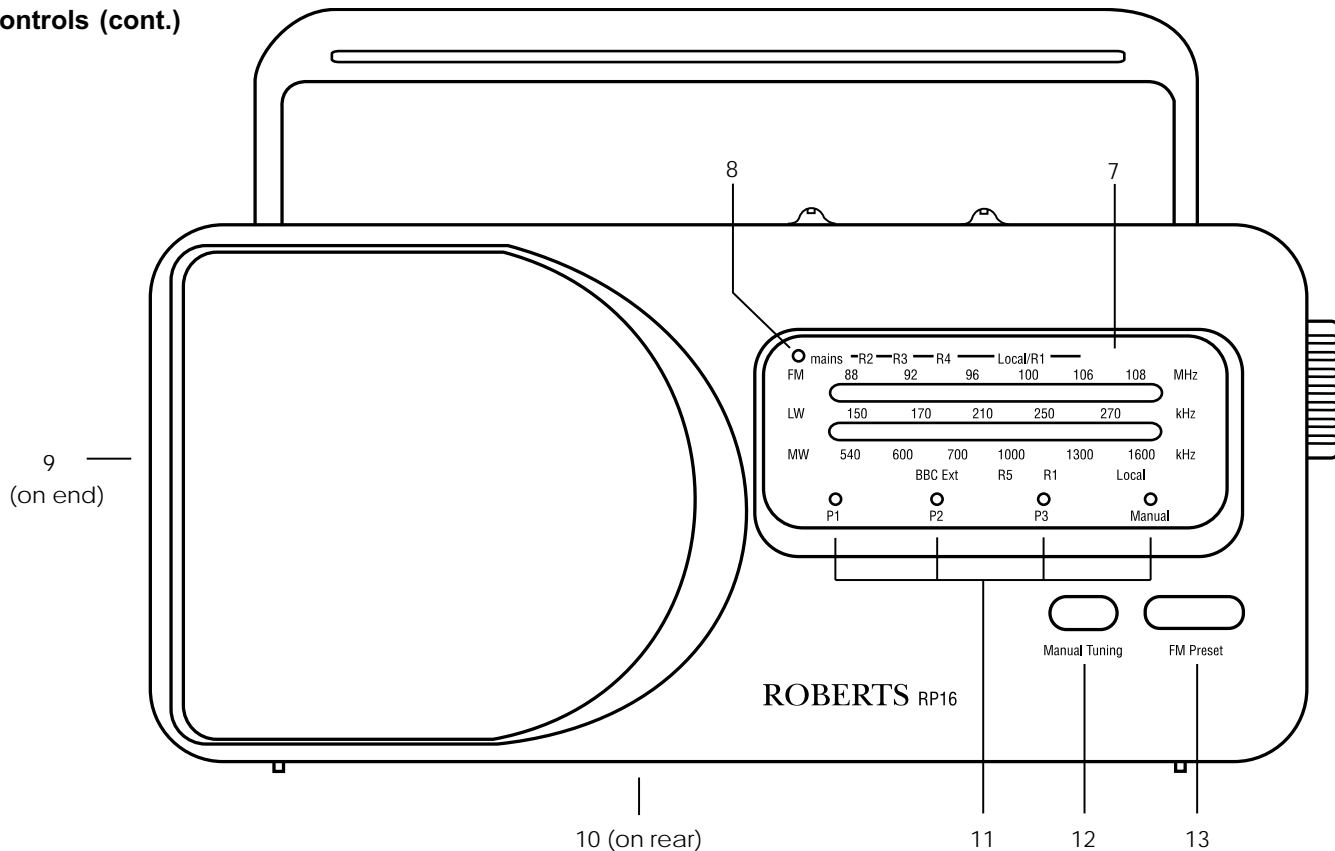

7. Tuning scale
8. Mains indicator

9. Mains input socket
10. Battery cover

11. Preset/Manual indicators
12. Manual tuning button

13. FM preset button

General

Do not allow this unit to be exposed to water, steam or sand. Do not leave the unit where excessive heat could cause damage such as in a parked car where the heat from the sun can build up even though the outside temperature may not seem too high. It is recommended that the FM band be used where ever possible as better results in terms of quality and freedom from interference will usually be obtained than on the MW or LW bands.

Mains supply

The RP16 will operate from a supply of 220/240 volts, 50/60Hz  only.

DO NOT cut off the mains plug from this equipment. If the plug fitted is not suitable for the power points in your home or the cable is too short to reach a power point, then obtain an appropriate safety approved extension lead or adaptor. If in doubt consult your dealer.

If nonetheless the mains plug is cut off, remove the fuse and dispose of the plug immediately, to avoid a possible shock hazard by inadvertent connection to the mains supply.

If this product is not supplied with a mains plug, or one has to be fitted, then follow the instructions given below:

IMPORTANT. DO NOT make any connection to the larger terminal which is marked with the letter E or by the safety earth symbol  or coloured Green or Green-and-yellow.

The wires in the mains lead are coloured in accordance with the following codes :-

BLUE - NEUTRAL

BROWN - LIVE

As these colours may not correspond with the coloured markings identifying the terminals in your plug, proceed as follows:

The wire coloured BLUE must be connected to the terminal marked N or coloured BLACK.

The wire coloured BROWN must be connected to the terminal marked L or coloured RED.

Fuse

When replacing the fuse only a 3A ASTA approved to BS1362 type should be used and be sure to re-fit the fuse cover.

IF IN DOUBT - CONSULT A COMPETENT ELECTRICIAN.

Replacement fuse holders are available from Roberts Radio at the address shown on the rear of this manual.

Batteries

Remove the battery cover (10) on the rear of the unit by pushing the catch in the direction of the arrow. Insert four IEC size R14 cells into the spaces in the compartment. Take care to ensure all cells are inserted with the correct polarity as shown inside the battery compartment. Replace the battery cover.

Reduced power, distortion, and a 'stuttering' sound are all signs that the batteries may need replacing.

If the radio is not to be used for any extended period of time it is recommended that the batteries are removed from the radio.

We would recommend for economy, that the RP16 is used on the mains whenever possible with battery operation for occasional or stand-by use only.

Automatic Mains/Battery switching

To change from battery to mains operation, simply plug the mains lead into the mains input socket (9) on the left hand end of the unit. Mains operation is shown by the mains indicator (8). The batteries will be automatically disconnected. It does not matter which way round the plug is inserted but make sure it is fully pushed home. The other end should be plugged into a domestic supply socket.

Aerials

On FM fully extend the telescopic aerial (5), angle and rotate for best reception.

On MW and LW stations are received on the built in ferrite rod aerial, rotate the entire radio to the position giving best reception.

The telescopic aerial is inoperative on MW and LW.

MW/LW Operation

Turn on the receiver by rotating the Volume control (2) clockwise until a click is heard. Set the waveband selector (4) to the MW or LW position. Rotate the volume control until a hissing sound is heard. Rotate the Tuning Knob (6) to select the desired station. On MW and LW the tuning scale (7) is marked in kilohertz (kHz). Rotate the receiver to the position giving best reception. Adjust the volume control to the required sound level. Set the tone control (3) to the desired position. To turn off the receiver rotate the Volume control (2) fully anticlockwise until a click is heard.

Note : The telescopic aerial is inoperative on MW and LW.

FM Manual Operation

Fully extend the Telescopic Aerial (5). Turn on the receiver by rotating the Volume control (2) clockwise until a click is heard. Set the waveband selector (4) to the FM position. Rotate the volume control until a hissing sound is heard. Rotate the Tuning Knob (6) to select the desired station. On FM the tuning scale (7) is marked in megahertz (MHz). Angle and rotate the telescopic aerial to the position giving best reception. Adjust the volume control to the required sound level. Set the tone control (3) to the desired position. To turn off the receiver rotate the Volume control (2) fully anticlockwise until a click is heard.

Setting the FM Presets

Fully extend the Telescopic Aerial (5). Turn on the receiver by rotating the Volume control (2) clockwise until a click is heard. Set the waveband selector (4) to the FM position. Rotate the volume control until a hissing sound is heard. Press the FM preset button (13) until the P1 Preset indicator is illuminated. Rotate the P1 preset tuning knob (14) to select the desired station. Press the FM preset button (13) until the P2 Preset indicator is illuminated. Rotate the P2 preset tuning knob (15) to select the desired station. Press the FM preset button (13) until the P3 Preset indicator is illuminated. Rotate the P3 preset tuning knob (16) to select the desired station.

Note: The preset tuning controls used on the RP16 are of a multi-turn type, enabling precise tuning of preset stations.

FM Preset operation

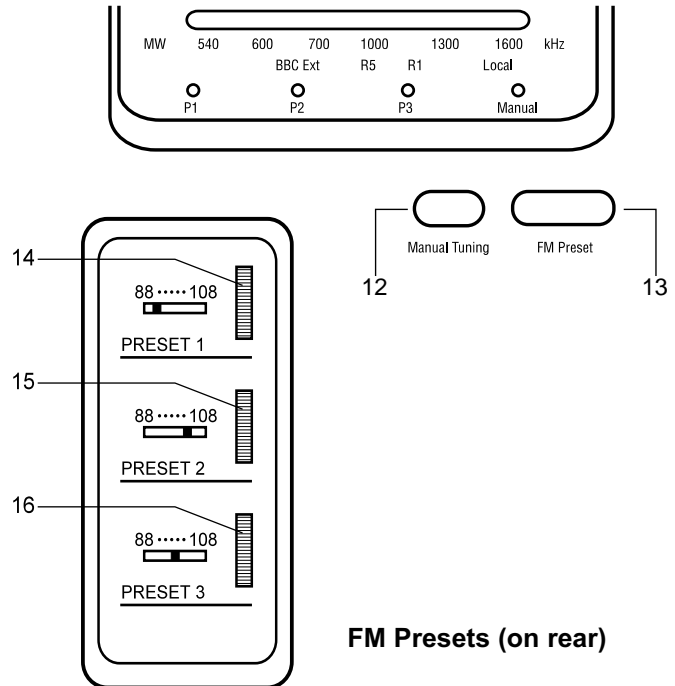

Fully extend the Telescopic Aerial (5). Turn on the receiver by rotating the Volume control (2) clockwise until a click is heard. Set the waveband selector (4) to the FM position. Rotate the volume control until a hissing sound is heard. Press the FM preset button (13) to select the required station. Repeated pressing of the FM preset button (13) will cycle through the presets in the order P1 - P2 - P3 - P1 - P2 - etc.



FM Presets (on rear)

Specifications

Power Requirements

Mains : 220/240volts, 50/60Hz  only
Batteries : 6.0V  4 x IEC R14 (C size) cells

Battery Life

Approx. 50hrs of listening for 4 hours a day at normal volume, using Alkaline cells.

Note: FM Preset stations will not remain in tune when the battery falls below 4.0V.

Frequency Coverage

FM 87.5-108MHz
MW 525 - 1605kHz
LW 147 - 284kHz

Circuit Features

3 IC's, 10 Transistors, 21 Diodes, 3 Varicap diodes, 3 Zener diode, 5 LED's.

Loudspeaker 100mm 4ohms

Output Power 1watt into 4ohms

Headphone socket 3.5mm dia

Aerial System FM Telescopic aerial

MW Built-in Ferrite aerial

LW Built-in Ferrite aerial

Guarantee

This instrument is guaranteed for twelve months from the date of delivery to the original owner against failure due to faulty workmanship or component breakdown, subject to the procedure stated below. Should any component or part fail during this guarantee period it will be repaired or replaced free of charge.

The guarantee does not cover:

1. Damage resulting from incorrect use.
2. Consequential damage.
3. Receivers with removed or defaced serial numbers.

N.B. Damaged or broken telescopic aerials will not be replaced under guarantee.

Procedure:

Any claim under this guarantee should be made through the dealer from whom the instrument was purchased. It is likely that your Roberts dealer will be able to attend to any defect quickly and efficiently, but should it be necessary the dealer will return the instrument to the company's service department for attention. In the event that it is not possible to return the instrument to the Roberts dealer from whom it was purchased, please contact Roberts Radio service department at the address shown on the back page of this manual before taking further action.

These statements do not affect the statutory rights of a consumer.

ROBERTS RADIO TECHNICAL SERVICES DEPARTMENT

97-99 Worton Road
Isleworth Middlesex
TW7 6EG

Technical Helpline:-0181 758 0338

Issue 2

