

# ROBERTS

Sound for Generations

# CR987

3 Band Dual Alarm  
Clock Radio

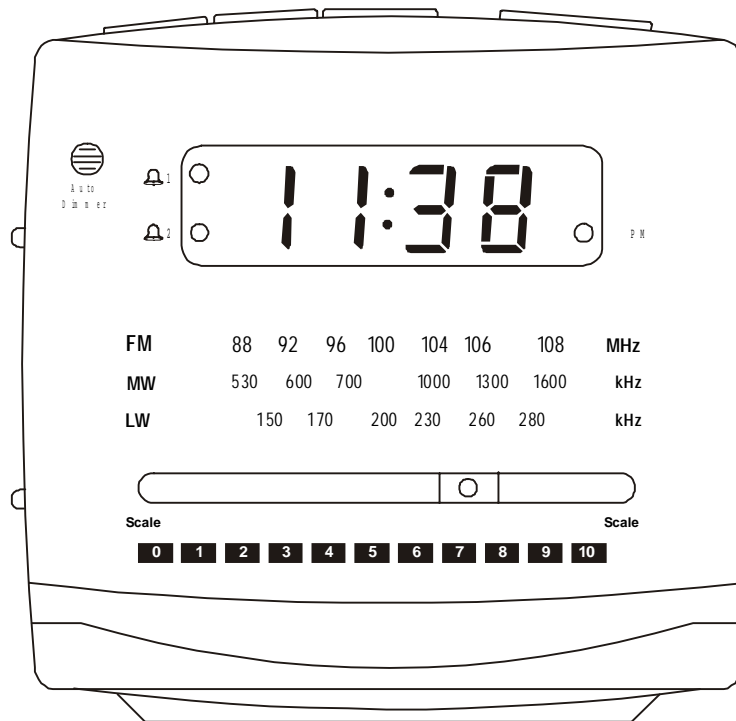

Please read this manual before use

# Controls (Front)

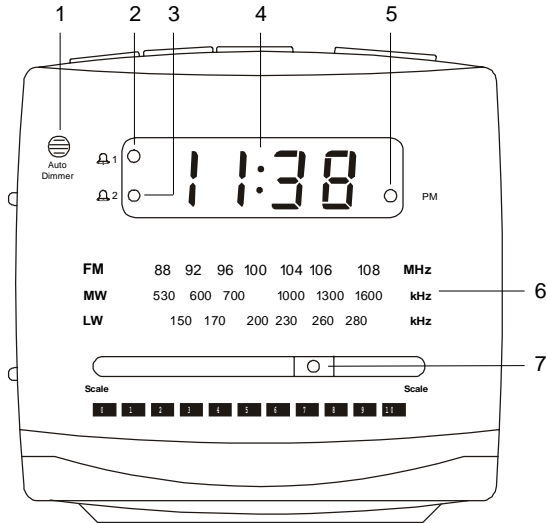

- 1. Auto dimmer
- 2. Alarm 1 indicator
- 3. Alarm 2 indicator
- 4. Clock display
- 5. PM indicator
- 6. Tuning scale
- 7. LED dial pointer

# (Top)

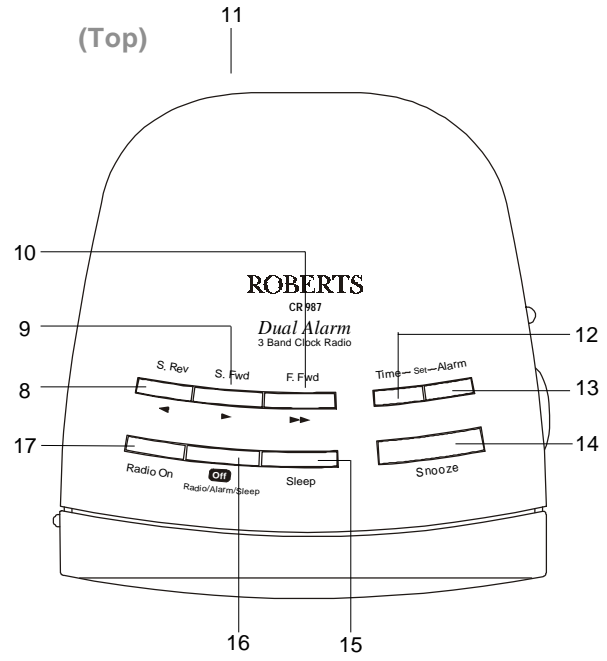

- 8. Slow reverse button
- 9. Slow forward button
- 10. Fast forward button
- 11. Wire aerial
- 12. Time set button
- 13. Alarm set button
- 14. Snooze button
- 15. Sleep button
- 16. Radio/Alarm/Sleep Off button
- 17. Radio On button

**Controls  
(Left side)**

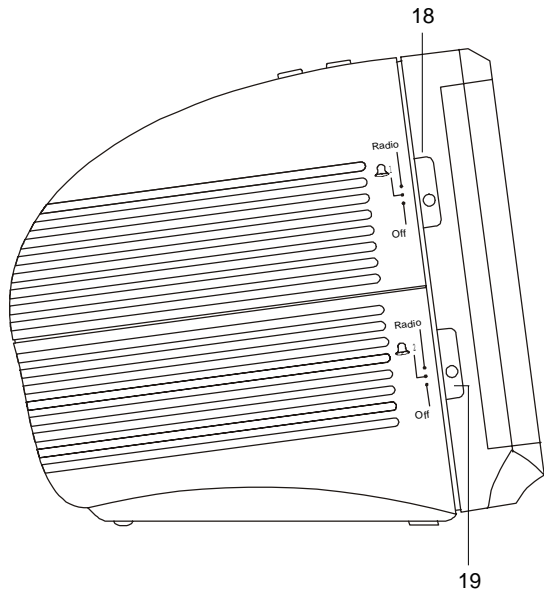

- 18. Alarm 1 function selector switch
- 19. Alarm 2 function selector switch

**(Right side)**

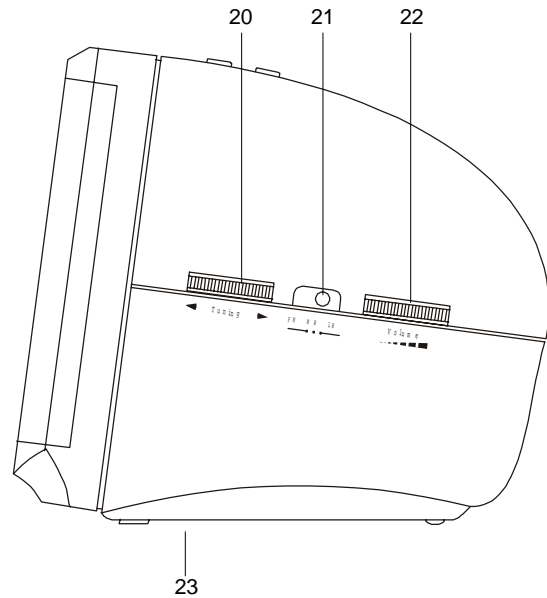

- 20. Tuning control
- 21. Waveband selector switch
- 22. Volume control
- 23. Battery compartment (underside)

## Switching on and setting the time

Before using your clock radio you must first set the correct time.

1. Place the unit on a flat surface. Plug the power cord into the wall socket and switch on.

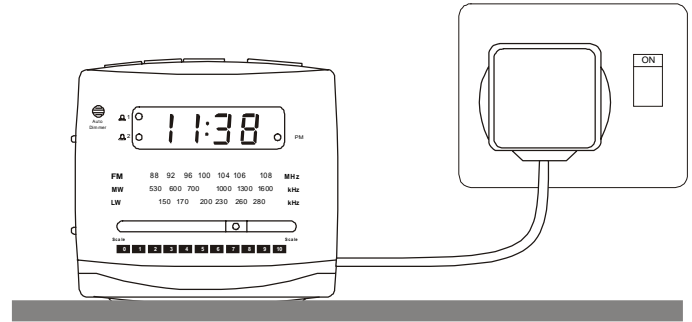

2. The clock display will flash 12.00.



3. Press and hold down the **Time Set button**.

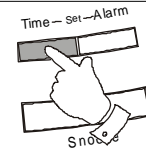

4. Whilst holding down the **Time Set button** press the fast forward (**F-Fwd**), slow forward (**S-Fwd**) or slow reverse (**S-Rev**) buttons to set the time. Release the buttons when the correct time is reached. The clock uses a 12 hour display with a **PM indicator**. Ensure that the correct 12 hour cycle is selected.

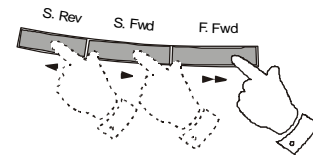

## Listening to the Radio

1. Turn on the radio by pressing the **Radio On button**. The **LED dial pointer** will light up indicating that the radio is switched on.

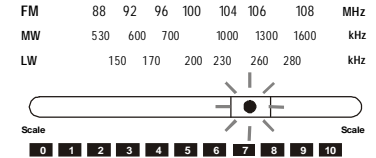
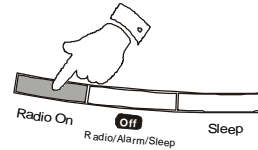

2. Select the required waveband using the **Waveband selector switch**.

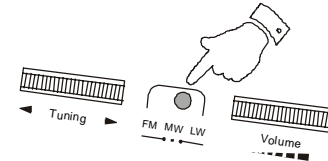

3. Tune in to the desired station by rotating the **Tuning control**. The station frequency is indicated by the **LED dial pointer**.

The **Wire aerial** located on the rear of your clock radio is for FM reception. The wire should be fully extended and positioned for optimum reception.

For MW and LW reception there is a built in ferrite aerial. Rotate your clock radio to the position giving best reception.

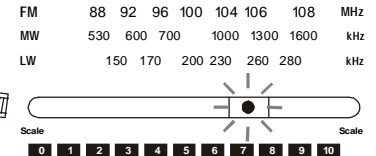
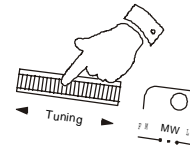

4. Adjust the volume by rotating the **Volume control**.

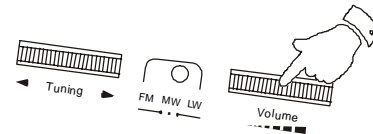

5. The radio can be switched off by pressing the **Radio/Alarm/Sleep Off** button.

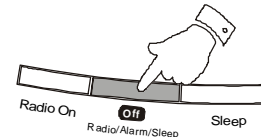

If you need any further advice, please call our Technical Helpline on :-  
0181 758 0338 (Mon-Fri)

## Setting alarm times

The alarms can be set to wake you by either the buzzer or the radio. Your alarm clock radio has 2 separate alarms which can be set to activate at different times.

### Setting alarm 1

1. Slide the **Alarm 1 function switch** to the Radio or  1 position.

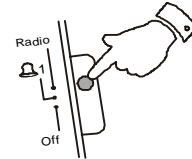

2. Press and hold down the **Alarm set button**.

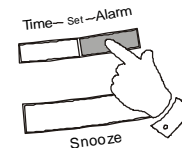

3. Whilst holding down the **Alarm Set button** press the fast forward (**F-Fwd**), slow forward (**S-Fwd**) or slow reverse (**S-Rev**) buttons to set the required alarm time. Release the buttons when the correct alarm time is reached. The clock uses a 12 hour display with a **PM indicator**. Ensure that the correct 12 hour cycle is selected.

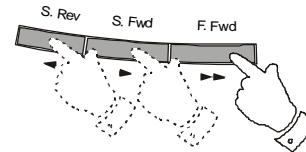

### Setting alarm 2

1. Ensure that the **Alarm 1 function switch** is set to the Off position. Slide the **Alarm 2 function switch** to the Radio or  2 position.

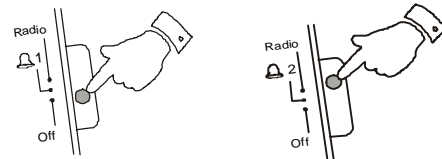

2. Press and hold down the **Alarm set button**.

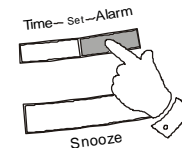

3. Whilst holding down the **Alarm Set button** press the fast forward (**F-Fwd**), slow forward (**S-Fwd**) or slow reverse (**S-Rev**) buttons to set the required alarm time. Release the buttons when the correct alarm time is reached. The clock uses a 12 hour display with a **PM indicator**. Ensure that the correct 12 hour cycle is selected.

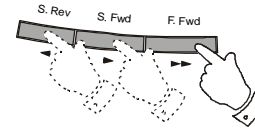

## Checking the Alarm Times

1. To check alarm 1 time, set the **Alarm 1 function switch** to the Radio or  1 position and ensure that the **Alarm 2 function switch** is set to the Off position .

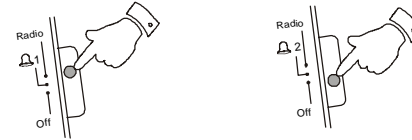

2. Press the **Alarm Set button** to display the alarm 1 time.



3. To check alarm 2 time, set the **Alarm 2 function switch** to the Radio or  2 position and ensure that the **Alarm 1 function switch** is set to the Off position .



4. Press the **Alarm Set button** to display the alarm 2 time.



## Setting the alarms to wake to buzzer

1. Set the alarm time as previously described. Set the **Alarm 1** or **Alarm 2 function selector** to the  position. The corresponding **Alarm 1** or **Alarm 2 indicator** will light.

The alarm will sound every day at the preset time for 59 minutes. To turn off the alarm until the next day press the **Radio/Alarm/Sleep Off button**. To turn off the alarms permanently set the **Alarm 1** or **Alarm 2 function selector** to the 'Off' position.

To make a distinction between alarm 1 and alarm 2 the alarm signals have a different sound pitch:

Alarm 1 = lower pitch alarm signal

Alarm 2 = higher pitch alarm signal

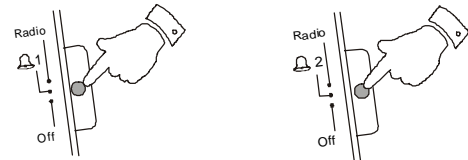

---

## Setting the alarms to wake to radio

1. Set the alarm time as previously described. Set the **Alarm 1** or **Alarm 2 function selector** to the 'Radio' position. The corresponding **Alarm 1** or **Alarm 2 indicator** will light.

Ensure that the volume is set to the correct level and the desired station is tuned in.

The radio will sound every day at the preset time for 59 minutes. To turn off the alarm until the next day press the **Radio/Alarm/Sleep Off button**. To turn off the alarms permanently set the **Alarm 1** or **Alarm 2 function selector** to the 'Off' position.

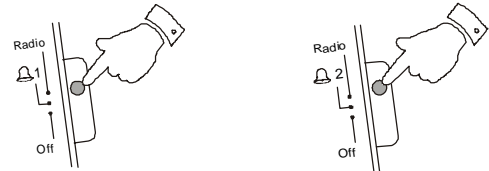

## Snooze control

The radio or buzzer alarm can be silenced for 6-7 minutes by pressing the **Snooze** button . This sequence can be repeated whilst the alarm is sounding.

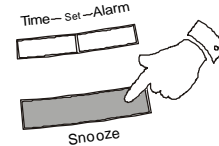

## Sleep timer

The radio can be set to turn off after a preset time has elapsed.

Press and hold down the **Sleep** button until the desired time is reached (maximum 59 minutes in 1 minute steps). The radio will switch off after the sleep time has elapsed.

The radio can be turned off at any time by pressing the **Radio/Alarm/Sleep Off** button

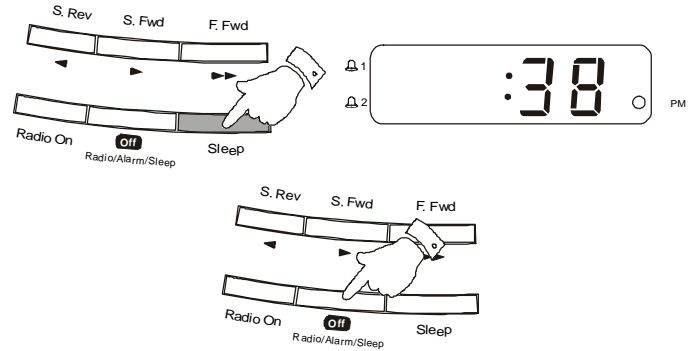

## Auto Dimmer

The **Auto Dimmer** located on the top left side of the LED display will automatically adjust the intensity of the clock display to suit room brightness.

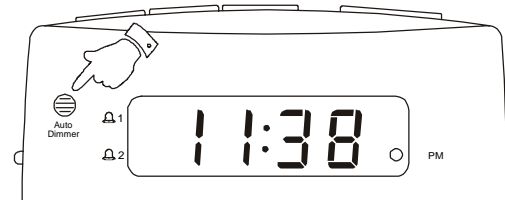

## Battery Back-up facility (see page 9)

The purpose of this battery is only to store information relating to the alarm times and to keep the clock functioning in case of disconnection from the mains supply or power interruption. Should this occur the clock will continue to run. The time and alarm settings will be retained but the LED display will not be operational .

*If you need any further advice, please call our Technical Helpline on :-  
0181 758 0338 (Mon-Fri)*

## General

Do not allow this unit to be exposed to water or steam. It is recommended that the FM band be used wherever possible as better results in terms of quality and freedom from interference will usually be obtained than on the MW or LW bands.

## Mains supply

The CR987 will operate from a supply of AC 230volts, 50Hz  $\sim$  only.

For your convenience this product is supplied with a plug which is fitted with a fuse of the appropriate rating. If the plug supplied is not suitable for your socket outlet, it should be removed by unscrewing the plug top, the terminal screws, and removing the cable.

The correct style of plug to suit your household together with a correctly rated fuse should be fitted.

IF IN DOUBT - CONSULT A QUALIFIED ELECTRICIAN

**IMPORTANT. DO NOT** make any connection to the larger terminal which is marked with the letter E or by the safety earth symbol  $\perp$  or coloured Green or Green-and-yellow.

The wires in the mains lead are coloured in accordance with the following codes :-

BLUE - NEUTRAL

BROWN - LIVE

As these colours may not correspond with the coloured markings identifying the terminals in your plug, proceed as follows:-

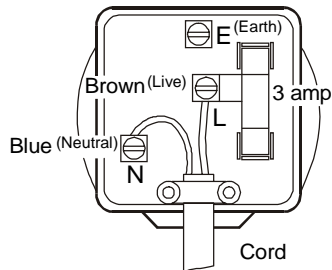

The wire coloured BLUE must be connected to the terminal marked N or coloured BLACK.

The wire coloured BROWN must be connected to the terminal marked L or coloured RED.

## Fuse

This apparatus must be protected by a 3A fuse (BS1362) in a 13A plug (BS1363). If another type of plug is used a 5A fuse should be fitted in the plug, adaptor or distribution board.

IF IN DOUBT - CONSULT A QUALIFIED ELECTRICIAN.

## Back-up Battery

Slide the battery cover catch in the direction of the arrow. Remove the battery cover. Fit a 9 volt IEC size 6F22 (6LR61, PP3) or equivalent battery into the compartment. Replace the battery cover.

The time and alarm settings will be retained during a temporary failure of the AC mains supply. The LED display will not be operational. The battery is not necessary for the unit to function. The display will be extinguished to conserve battery life, but the memory will retain details of the time and alarm time settings.

## (Underside)

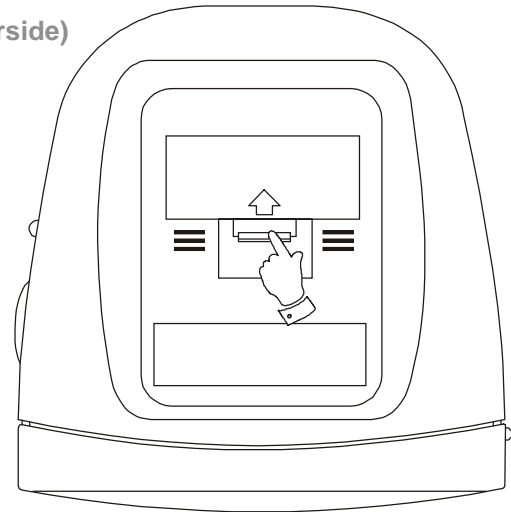

## Specifications

### Power Requirements

Mains	AC 230 volts, 50Hz  only
Back-up Battery	IEC size 6F22 (6LR61, PP3)

### Frequency Coverage

FM	87.5 - 108MHz
MW	525 - 1610kHz
LW	147- 284kHz

## Circuit Features

Loudspeaker	75mm diameter 8 ohms
Output Power	0.3W RMS
Aerial System	FM    Wire Aerial
	MW    Built-in Ferrite aerial
	LW    Built-in Ferrite aerial

### ROBERTSRADIOLIMITED

PO BOX 130  
MEXBOROUGH  
SOUTH YORKSHIRE  
S64 8YT

*The Company reserves the right to amend the specification without notice.*

*If you need any further advice, please call our Technical Helpline on :-*

*0181 758 0338 (Mon-Fri)*

## Guarantee

This instrument is guaranteed for twelve months from the date of delivery to the original owner against failure due to faulty workmanship or component breakdown, subject to the procedure stated below. Should any component or part fail during this guarantee period it will be repaired or replaced free of charge.

The guarantee does not cover:

1. Damage resulting from incorrect use.
2. Consequential damage.
3. Receivers with removed or defaced serial numbers.

Procedure:

Any claim under this guarantee should be made through the dealer from whom the instrument was purchased. It is likely that your Roberts dealer will be able to attend to any defect quickly and efficiently, but should it be necessary the dealer will return the instrument to the company's service department for attention. In the event that it is not possible to return the instrument to the Roberts dealer from whom it was purchased, please contact Roberts Radio Technical Services department at the address shown below before taking further action.

*These statements do not affect the statutory rights of a consumer.*

### **ROBERTS RADIO TECHNICAL SERVICES DEPARTMENT**

97-99 Worton Road  
Isleworth Middlesex  
TW7 6EG

Technical Helpline:- 0181 758 0338 (*Mon-Fri*)

Issue 1

