

ROBERTS

Sound for Generations

CR966

2 Band Stereo CD
Clock Radio

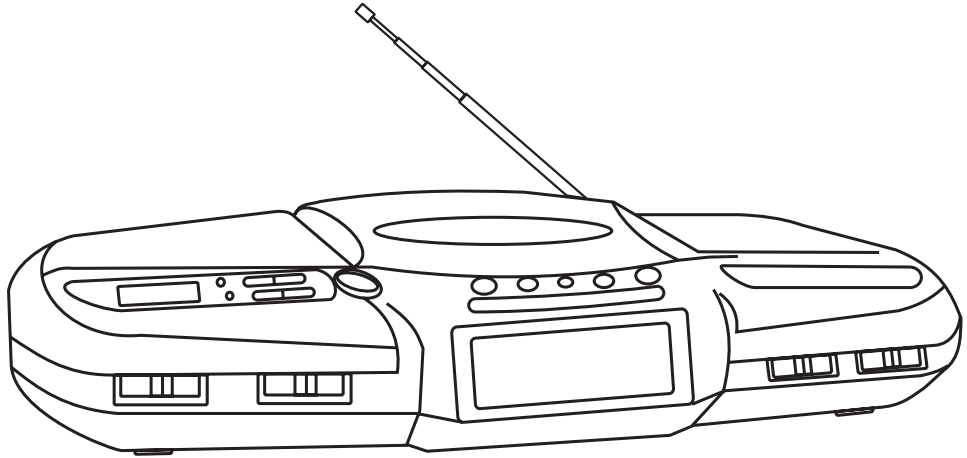

Please read this manual before use

Controls

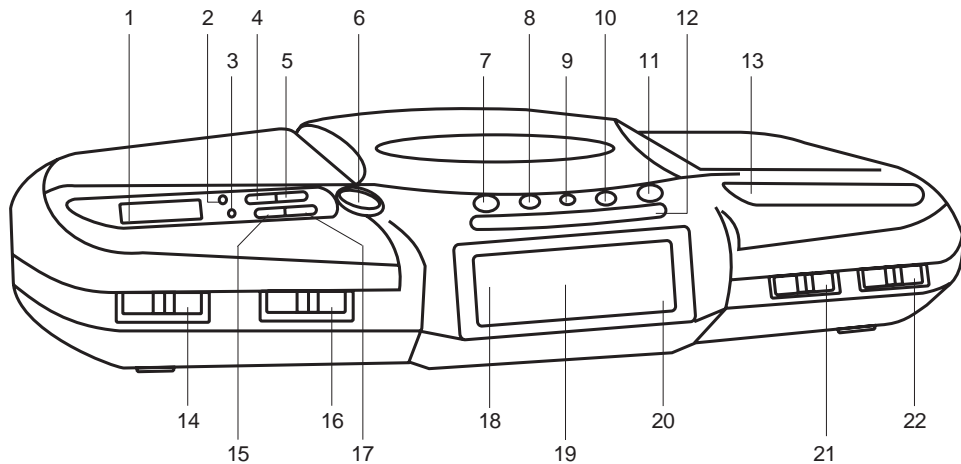

- | | | | |
|-------------------------------|---------------------|----------------------------|-----------------------------|
| 1. LCD CD display | 7. Time set button | 13. FM stereo indicator | 19. LED clock display |
| 2. CD repeat button | 8. Alarm set button | 14. Deep bass boost switch | 20. Alarm indicator |
| 3. CD memory button | 9. Hour button | 15. Play/Pause button | 21. Buzz/Auto/Off/On switch |
| 4. Skip/search reverse button | 10. Minute button | 16. Dimmer switch | 22. CD/FM ST./FM/MW switch |
| 5. Skip/search forward button | 11. Sleep button | 17. Stop button | |
| 6. Open button | 12. Snooze button | 18. PM indicator | |

Controls (cont.)

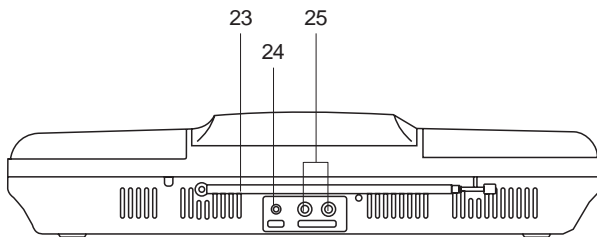

- 23. Telescopic aerial
- 24. Headphone socket
- 25. CD line output sockets
- 26. Tuning control
- 27. Volume control
- 28. Battery compartment

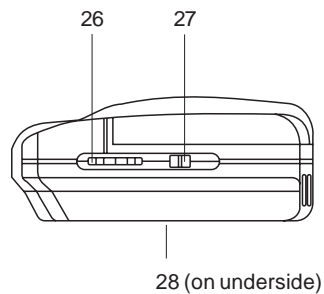

General

Do not allow this unit to be exposed to water or steam. Do not leave the unit where excessive heat could cause damage. It is recommended that the FM band be used wherever possible as better results in terms of quality and freedom from interference will usually be obtained than on the MW band.

Mains supply

The CR966 will operate from a supply of AC 230 volts, 50Hz  only.

For your convenience this product is supplied with a plug which is fitted with a fuse of the appropriate rating. If the plug supplied is not suitable for your socket outlet, it should be removed by unscrewing the plug top, the terminal screws, and removing the cable.

The correct style of plug to suit your household together with a correctly rated fuse should be fitted.

IF IN DOUBT - CONSULT A QUALIFIED ELECTRICIAN

IMPORTANT. DO NOT make any connection to the larger terminal which is marked with the letter E or by the safety earth symbol  or coloured Green or Green-and-yellow.

The wires in the mains lead are coloured in accordance with the following codes :-

BLUE - NEUTRAL

BROWN - LIVE

As these colours may not correspond with the coloured markings identifying the terminals in your plug, proceed as follows:

The wire coloured BLUE must be connected to the terminal marked N or coloured BLACK.

The wire coloured BROWN must be connected to the terminal marked L or coloured RED.

Fuse

This apparatus must be protected by a 3A fuse (BS1362) in a 13A plug (BS1363). If another type of plug is used a 5A fuse should be fitted in the plug, adaptor or distribution board.

IF IN DOUBT - CONSULT A QUALIFIED ELECTRICIAN.

Back-up battery

Slide the battery cover catch (28) in the direction of the arrow. Remove the battery cover. Fit a 9 volt IEC size 6LR61 (6F22) or equivalent battery into the compartment. Replace the battery cover. The time and alarm settings will be retained during a temporary failure of the AC mains supply. The LED display (19) will not be operational. The battery is not necessary for the unit to function.

Aerials

The telescopic aerial (23) located on the rear of the CR966 is for FM reception. The telescopic aerial should be fully extended and angled for optimum reception

There is a built in ferrite aerial for MW stations. Rotate the CR966 to the position giving best reception.

Setting the time

Press and hold down the time set button (7). Use the hour (9) and minute (10) buttons to adjust the time to the required setting. Release the time set button when the required time is reached.

Note: The clock uses a 12 hour display with a PM indicator (18). Ensure that the correct 12 hour cycle is selected.

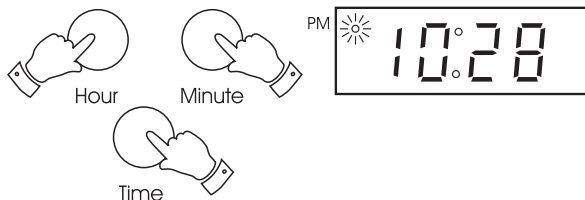

Radio operation (FM)

Slide the Buzz/Auto/Off/On switch (21) to the "On" position. Slide the CD/FM ST./FM/MW switch (22) to the "FM ST." position. Adjust the volume control (27) until a hissing sound is heard. Rotate the tuning control (26) until the desired station is received. If the station being received is in 'Stereo' the stereo indicator (13) will illuminate. Adjust the volume control (27) to the required sound level.

If the FM signal becomes weak or is accompanied by a high level of background hiss, you may select 'MONO' mode by setting the CD/FM ST./FM/MW switch (22) to the "FM" position. To switch off the radio, slide the Buzz/Auto/Off/On switch (21) to the "Off" position.

Radio operation (MW)

Slide the Buzz/Auto/Off/On switch (21) to the "On" position. Slide the CD/FM ST./FM/MW switch (22) to the "MW" position. Adjust the volume control (27) until a hissing sound is heard. Rotate the tuning control (26) until the desired station is received. Rotate the CR966 to the position giving best reception. Adjust the volume control (27) to the required sound level.

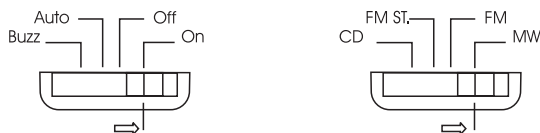
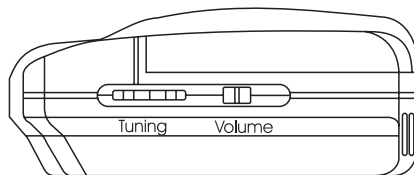
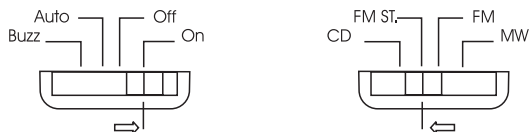

CD operation

Playing a disc

Press the open button (6) to open the CD compartment. Carefully place a disc onto the spindle in the CD compartment, ensuring that the label is facing upwards. Close the lid ensuring it latches shut. Slide the Buzz/Auto/Off/On switch (21) to the "On" position and the CD/FM ST./FM/MW switch (22) to the "CD" position. The CR966 will automatically play the disc as soon as the CD/FM ST./FM/MW switch is set to the "CD" position or the CD compartment is closed.

Pausing during CD play

Whilst the CD is playing, press the play/pause button (15) to pause play. The disc will continue rotating, but play will stop and the pause symbol will appear on the LCD display(1). To resume play, press the play/pause button (15) again. The pause symbol will disappear from the LCD display.

Stopping CD play

To stop CD play, press the stop button (17) once. The disc will stop rotating and the display will revert to showing the total number of tracks and time.

Skip function

Whilst the CD is playing, press either the skip forward (5) or skip reverse (4) buttons to change to the desired track. You can also skip tracks when the player is in stop mode. Skip to the desired track using the skip/search forward (5) or skip/search reverse (4) buttons and press the play/pause button (15) to commence play of the selected track.

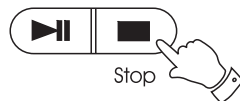
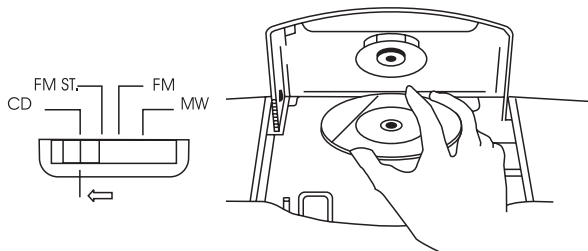

Search function

Whilst the CD is playing, press and hold either the skip/search forward (5) or skip/search reverse (4) buttons. Release the button when the desired part of the track is reached.



Repeat function

To repeat only one track, press the repeat button (2) until the LCD display shows REP 1.

To repeat all tracks on a disc, press the repeat button (2) until the LCD display shows REP.

To cancel the repeat function, press the repeat button (2) until the word REP 1 or REP is remove from the LCD display.



TRACK MIN SEC

Programmed play

With programmed play you can program up to 21 tracks on a disc in any order you chose.

Press the memory button (3) to enter program mode. Use the skip/search buttons to select the desired track. Press the memory button to store the selected track and move to the next memory location, use the skip/search buttons to select the next track in the program. Repeat the above steps until you have completed your program. Press the play/pause button (15) to commence play of your selected tracks. When all tracks in the program have been played the player will automatically stop.



TRACK MIN SEC



TRACK MIN SEC

Cancelling programmed play

Slide the Buzz/Auto/Off/On switch (21) to the "Off" position, this clears all programmed selections from memory.

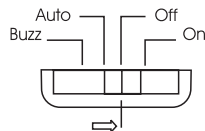

If you need any further advice, please
call our Technical Helpline on
0181 758 0338 (Mon-Fri)

Setting the alarm time

Press and hold down the alarm set button (8). Use the hour set (9) and minute set (10) buttons to adjust the time to the required setting. Release the alarm set button when the required time is reached.

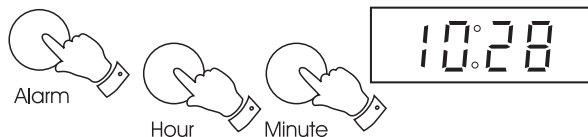

Wake up to buzzer

Set the alarm time as described above. Slide the Buzz/Auto/Off/On switch (21) to the "Buzz" position. The alarm will now sound at the preset time. To cancel the buzzer alarm slide the Buzz/Auto/Off/On switch (21) to the "Off" position.

Wake up to radio

Tune in to the required station and adjust the volume control (28) to the level which you wish to wake up to. Set the alarm time as described above. Slide the Buzz/Auto/Off/On switch (21) to the "Auto" position. The radio will now turn on at the preset time. To cancel the radio alarm slide the Buzz/Auto/Off/On switch (21) to the "Off" position.

Wake up to CD

Press the open button (6) to open the CD compartment. Carefully place a disc onto the spindle in the CD compartment, ensuring that the label is facing upwards. Close the lid ensuring it latches shut. Adjust the volume control (26) to the level which you wish to wake up to. Slide the CD/FM ST./FM/MW switch (22) to the "CD" position. Slide the Buzz/Auto/Off/On switch (21) to the "Auto" position. The CD will now play at the preset time. To cancel the CD alarm slide the Buzz/Auto/Off/On switch (21) to the "Off" position.

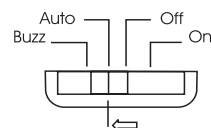
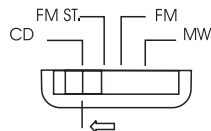
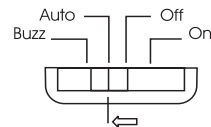
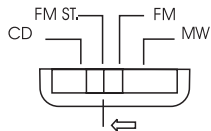
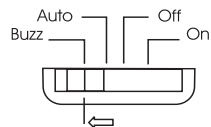

Alarm indicator

The alarm indicator (20) will illuminate when the Buzz/Auto/Off/On is set to the "Buzz" or "Auto" indicating that the alarm is set.

Snooze function

The buzzer, radio or CD alarm can be silenced for 9 minutes by pressing the snooze button (12). This sequence can be repeated within the 60 minute alarm period.

Sleep function

The radio or CD can be set to turn off after a preset time has elapsed. Set the CD/FM ST./FM/MW switch (22) to the required position. Tune in to the desired station or place a disc into the CD compartment.

Slide the Buzz/Auto/Off/On switch (21) to the "Auto" position. Press and hold down the sleep button (11). Use the hours and minutes buttons to select the length of time you would like the unit to play (maximum 1 hour) 59 minutes in 1 minute steps. The unit will switch off after the sleep time has elapsed.

Dimmer switch

The brightness of the clock display can be adjusted using the dimmer control (16).

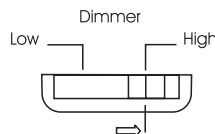
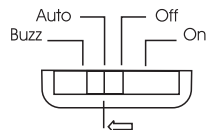

Deep bass boost switch

Setting the deep bass boost switch (14) to the "On" position will enhance bass sounds.

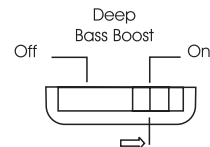

Headphones

A 3.5mm socket (24) on the rear of the CR966 is provided for use with stereo headphones. Inserting a plug into this socket automatically mutes the internal loudspeakers.

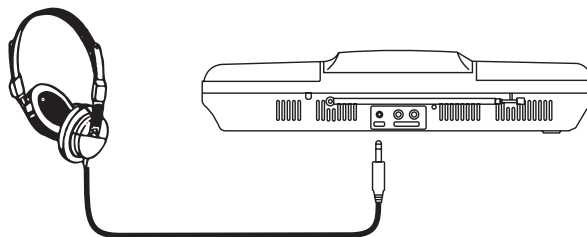

CD line output sockets

Two phono sockets (25) located on the rear of the CR966 enable the output of the CD player to be played through an audio system. Before connecting the CR966 ensure that the power to your audio system is switched off. Connect the CD line output sockets to the CD or AUX input sockets of your audio system using a suitable lead (not included).

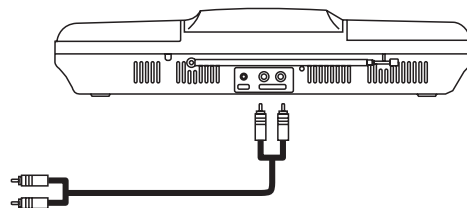

Specifications

Power Requirements

Mains	AC 230 volts, 50Hz  only
Back-up Battery	IEC size 6LR61 (6F22)

General

Output Power	2 x 1W RMS
Loudspeakers	2 x 80mm
Line output socket	Impedance 50k ohms
Headphone socket	Impedance 32 ohms

Disc player

Sampling frequency	44.1kHz
Frequency response	20Hz-20kHz +3db -3dB

Radio

Frequency Coverage

FM	87.5 -108MHz
MW	530 - 1605kHz

Aerial System

FM	Telescopic aerial
MW	Built-in Ferrite aerial

**CLASS 1
LASER PRODUCT**



DANGER: INVISIBLE LASER
RADIATION WHEN OPEN
AND INTERLOCK FAILED
OR DEFEATED. AVOID
DIRECT EXPOSURE TO BEAM.

Imported by:-

ROBERTS RADIO LIMITED
PO BOX 130
MEXBOROUGH
SOUTH YORKSHIRE
S64 8YT

The Company reserves the right to amend the specification without notice.

Guarantee

This instrument is guaranteed for twelve months from the date of delivery to the original owner against failure due to faulty workmanship or component breakdown, subject to the procedure stated below. Should any component or part fail during this guarantee period it will be repaired or replaced free of charge.

The guarantee does not cover:

1. Damage resulting from incorrect use.
2. Consequential damage.
3. Receivers with removed or defaced serial numbers.

N.B. Damaged or broken telescopic aerials will not be replaced under guarantee.

Procedure:

Any claim under this guarantee should be made through the dealer from whom the instrument was purchased. It is likely that your Roberts dealer will be able to attend to any defect quickly and efficiently but should it be necessary the dealer will return the instrument to the company's service department for attention. In the event that it is not possible to return the instrument to the Roberts dealer from whom it was purchased, please contact Roberts Radio Technical Services department at the address shown below before taking further action.

These statements do not affect the statutory rights of a consumer.

ROBERTS RADIO TECHNICAL SERVICES DEPARTMENT

97-99 Worton Road

Isleworth Middlesex

TW7 6EG

Technical Helpline :- 0181 758 0338

Issue 1

