

# ROBERTS

## Enjoy Listening

**DAB**

Digital Audio Broadcasting

# solarDAB™ 2

DAB / FM RDS digital solar radio



Please read this manual before use

## Contents

<i>Controls</i> .....	2-3	<i>Scan sensitivity - FM</i> .....	20
<i>Battery operation using rechargeable batteries</i> .....	4	<i>Software version</i> .....	21
<i>Battery operation using alkaline batteries</i> .....	5	<i>System reset</i> .....	22
<i>Using the AC adaptor</i> .....	6	<i>Headphone socket</i> .....	23
<i>Using solar power</i> .....	7	<i>Auxiliary input socket</i> .....	23
<i>Operating your radio - DAB</i> .....	8	<i>A few words about batteries</i> .....	24-25
<i>Selecting a station - DAB</i> .....	9	<i>Display backlight</i> .....	26
<i>Display modes - DAB</i> .....	10	<i>General</i> .....	27
<i>Finding new stations - DAB</i> .....	11	<i>Specifications</i> .....	28
<i>Secondary services - DAB</i> .....	11	<i>Circuit features</i> .....	28
<i>Manual tuning - DAB</i> .....	12	<i>Notes</i> .....	29
<i>Signal strength display - DAB</i> .....	12	<i>Guarantee</i> .....	30
<i>Dynamic range control (DRC) settings - DAB</i> .....	13		
<i>Operating your radio - Search tuning - FM</i> .....	14		
<i>Manual tuning - FM</i> .....	15		
<i>Display modes - FM</i> .....	16		
<i>Favourite button</i> .....	17		
<i>Recalling your favourite station</i> .....	17		
<i>Preset stations DAB and FM</i> .....	18		
<i>FM stereo/mono (Headphones only)</i> .....	19		

## Controls

(Front)

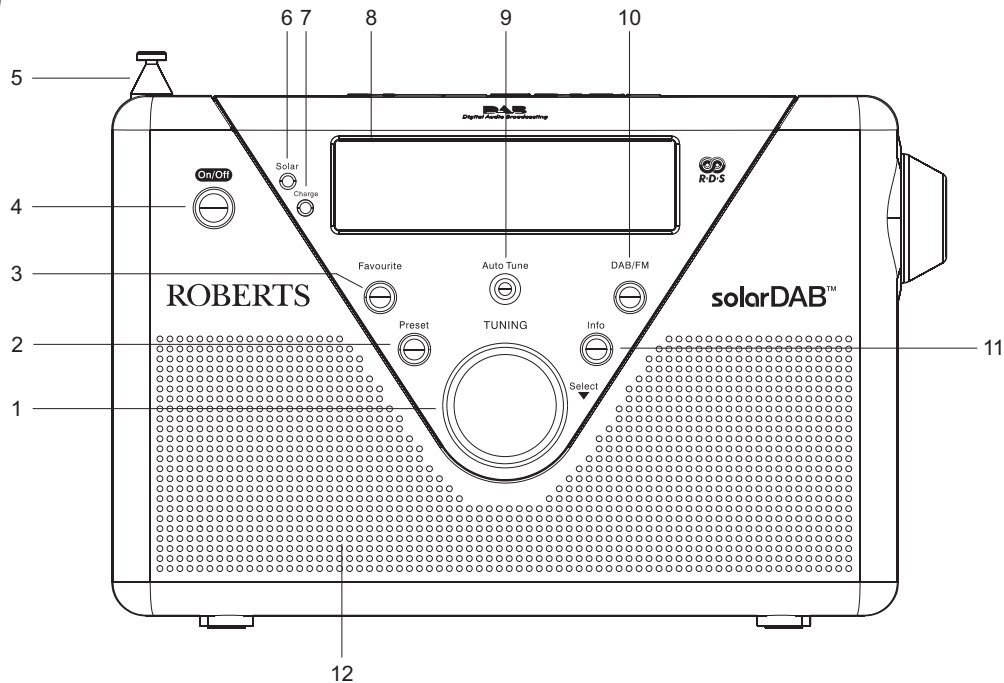

- |                     |                                   |                     |
|---------------------|-----------------------------------|---------------------|
| 1. Tuning control   | 5. Telescopic aerial              | 9. Auto Tune button |
| 2. Preset button    | 6. Solar indicator                | 10. DAB / FM button |
| 3. Favourite button | 7. Charge / Low battery indicator | 11. Info button     |
| 4. On / Off button  | 8. LCD display                    | 12. Speaker         |

## Controls

- 13. Volume control
- 14. Headphone socket
- 15. USB socket
- 16. Auxiliary input socket
- 17. DC input socket
- 18. Battery compartment

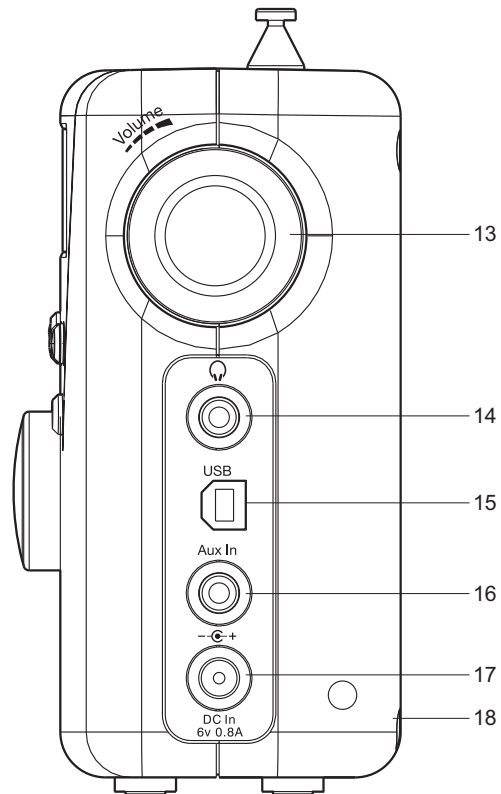

## Battery operation using rechargeable batteries - included (also see page 24)

1. Remove the battery cover on the back of the unit by pushing the battery door in slightly and then downwards in the direction of the arrows in the diagram.
2. Slide the switch inside the battery compartment to the **NiMH/NiCad** position.
3. Insert three Rechargeable LR6 (AA size) batteries into the spaces in the compartment. Take care to ensure all batteries are inserted with the correct polarity as shown on the back of the radio. The radio is designed to be used with Nickel Metal Hydride (NiMH) or Nickel Cadmium (NiCad) rechargeable batteries.
4. Plug the mains adaptor into your radio and then plug the adaptor into the mains.
5. The Charge light will flash green indicating batteries are charging. Batteries will be fully charged in around 7 hours. The battery light shows a steady green light when the battery charging is complete.

- **Important: when using rechargeable batteries the battery switch must be placed in the NiMH/NiCad position. Batteries will only be charged when the radio is switched off and connected to the AC adaptor.**
- When the batteries are exhausted, the battery light will show red for a short while. The radio will then switch itself off. It may not be possible to switch the radio back on until the batteries are recharged, or until the radio is connected to the mains adaptor.
- If the radio is not to be used for any extended period of time it is recommended that the batteries are removed from the radio.

**IMPORTANT:** The batteries should not be exposed to excessive heat such as sunshine, fire or the like. After use, disposable batteries should if possible be taken to a suitable recycling centre. On no account should batteries be disposed of by incineration.

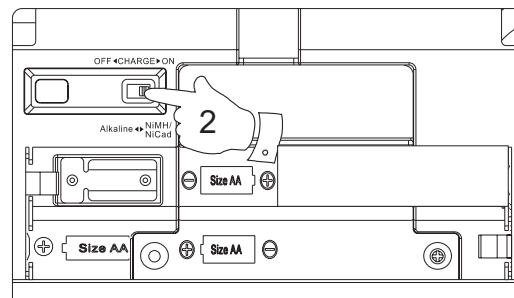
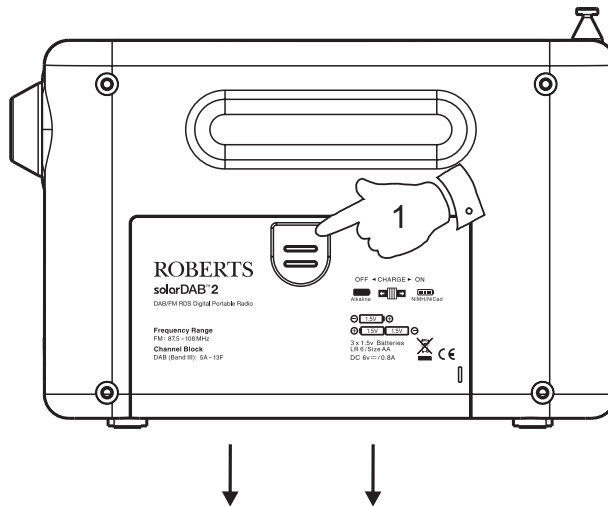

## Battery operation using alkaline batteries (also see page 24)

1. Remove the battery cover on the back of the unit by pushing the battery door in slightly and then downwards in the direction of the arrows in the diagram.
2. Slide the switch inside the battery compartment to the **Alkaline** position.
3. Insert three LR6 (AA size) alkaline batteries into the spaces in the compartment. Take care to ensure all batteries are inserted with the correct polarity as shown on the back of the radio. Then replace the battery cover.

- **Important: when using alkaline batteries the battery switch must be placed in the alkaline position. Failure to do so could result in serious damage to the batteries or radio.**
- When the batteries are exhausted, the battery light will show red for a short while. The radio will then switch itself off. It may not be possible to switch the radio back on until the batteries are replaced, or until the radio is connected to the mains adaptor.
- If the radio is not to be used for any extended period of time it is recommended that the batteries are removed from the radio.
- *We would recommend for economy that the solarDAB 2 is used via the AC adaptor whenever possible with battery operation for occasional or stand-by use only. If extended listening using batteries is anticipated, then the use of rechargeable batteries is recommended.*

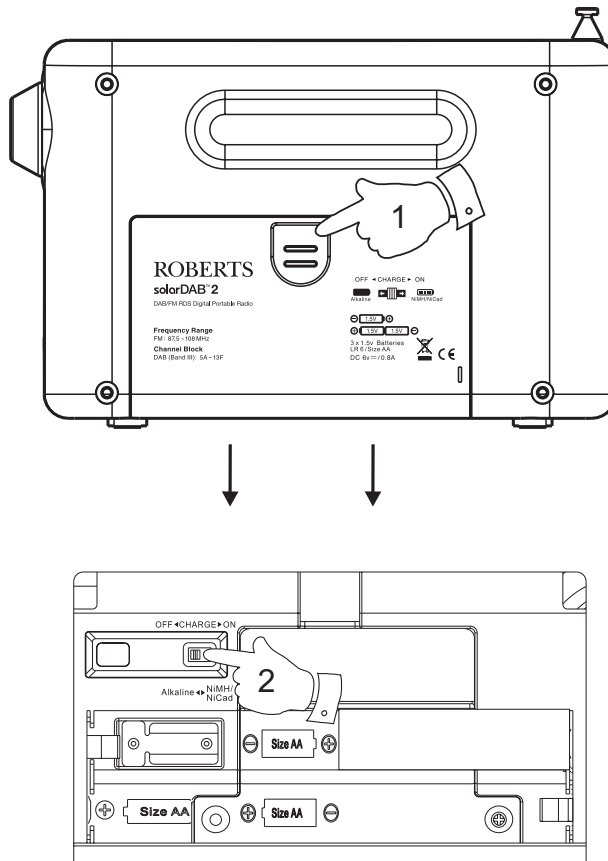

## Using the AC adaptor

1. Insert the adaptor plug into the DC in socket on the right hand side of your radio.
2. Plug the adaptor into a standard 13A mains socket outlet. Whenever the adaptor is plugged in to the radio and switched on at the mains the batteries are automatically disconnected. If the adaptor is plugged in to the radio but not switched on then the radio will run from the batteries if fitted.

*The AC adaptor should be disconnected from the mains supply and the radio when not in use.*

- **IMPORTANT:** The mains adaptor is used as the means of connecting the radio to the mains supply. The mains socket used for the radio must remain accessible during normal use. In order to disconnect the radio from the mains completely, the mains adaptor should be removed from the mains socket outlet completely.

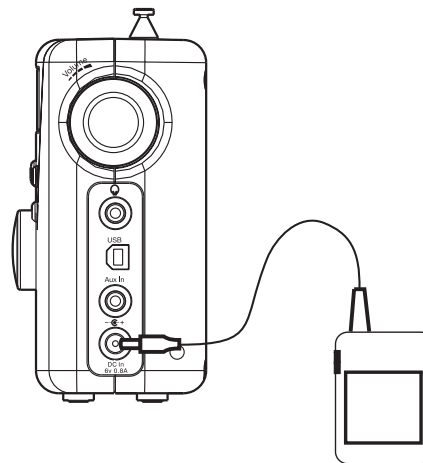

## Using solar power

**Important - The radio does not need to be switched on in order for the solar panel to operate.**

1. In order to recharge your solarDAB radio's batteries using solar power, position the radio so that its integral solar panel receives direct sunlight. The more sunlight that falls on the solar panel - the more electricity it can generate to power the radio.
2. The solar indicator should be used as a positioning aid to achieve the greatest output from the solar panel.
3. The brightness of the solar indicator shows the level of solar energy reaching the solar panel.
4. Adjust the position of the radio so as to achieve maximum brightness of the solar indicator.

NOTE: Best performance of the solar panel will be achieved when the sun is directly overhead, and the sunlight is unobstructed by clouds, foliage, curtains, and the like. In certain situations and poorer light conditions, the solar panel may not be effective and should not be relied upon as the primary energy source for standard usage. The solar panel is designed as a supplementary energy source which under suitable light conditions is able to contribute up to 100% of the radio's energy requirement.

The solar panel will only deliver power to the radio, or charge the batteries under natural sunlight. It will not deliver charge in artificial light.

Do NOT attempt to charge the batteries by placing the solar panel directly under any kind of sun-lamp. This will cause irreversible damage to the radio and may damage the casing.

## Operating your radio - DAB

1. Carefully extend the telescopic aerial.
2. Press the **On/Off button** to switch on your radio. The display will show "Welcome to DAB".
3. If this is the first time the radio is used a quick scan of the Band III DAB channels will be carried out. If the radio has been used before the last used station will be selected.
4. During the scanning process, the lower line of the display shows a bar-graph indicating progress of the scan.
5. When the scanning is completed the first station (in numeric-alpha order 0...9...A...Z) will be selected.
6. If the station list is still empty after the scan your radio will display "Service not available".
7. If no signals are found it may be necessary to relocate your radio to a position giving better reception. Then, either switch your radio off and on again, or press the **Auto Tune button** to repeat the scan.

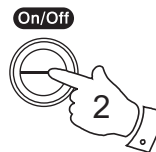

Welcome to DAB  
■■■■■■■■■■

BBC R7      DAB  
Now tuning...

BBC R7      DAB  
Im sorry I have

Classic      DAB  
Service not avai

## Selecting a station - DAB

1. The top line of the display shows the name of the station currently selected.
2. Rotate the **Tuning control** to scroll through the list of available stations on the lower line of the display. Stop rotating the Tuning control when you find the station that you wish to hear.
3. Press and release the **Tuning control** to select the station. The display may show "Now tuning..." while your radio finds the new station.
4. Adjust the **Volume control** to the required setting.

Note: If after selecting a station the display shows "Service not available" it may be necessary to relocate your radio to a position giving better reception.

The use of radio station presets for selecting your preferred radio stations is described on page 18.

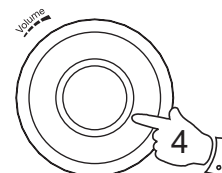
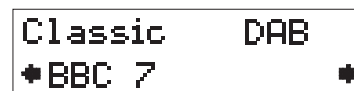
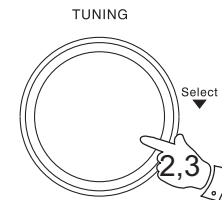

## Display modes - DAB

Your radio has a range of display modes:-

1. Press the **Info button** to cycle through the various modes.

- a. Scrolling text            Displays scrolling text messages such as artist/track name, phone in number etc.
- b. Program Type            Displays the type of station being listened to e.g. Pop, Classic, News etc.
- c. Multiplex Name           Displays the name of DAB multiplex to which the current station belongs.
- d. Time and date            Displays the current time and date.
- e. Frequency                Displays the frequency of the DAB multiplex for the station listened to.
- f. Bit rate & audio type     Displays the digital bit rate & audio type for the station being listened to.
- g. Signal Strength           Displays a graph showing the signal strength for the station being received.

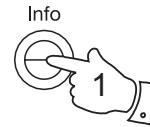

a    BBC R7            DAB  
      Im sorry I have

b    BBC R7            DAB  
      Varied Speech

c    BBC R7            DAB  
      BBC National DAB

d    BBC R7            DAB  
      19:17 08-06-2008

e    BBC R7            DAB  
      12B 225.64MHz

f    BBC R7            DAB  
      80kbps / MP2

g    BBC 7             DAB  
      ■■■■■ □■■■■

## Finding new radio stations - DAB

As time passes new stations may become available. To find new stations proceed as follows:-

1. Press and release the **Auto Tune button**. The display will show "Scanning..." and your radio will perform a scan of the Band III DAB channels. As new radio stations are found the station counter on the right-hand side of the display will increase and the radio stations will be added to the list stored in the radio.

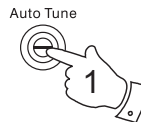

---

## Secondary services - DAB

1. Certain radio stations have one or more secondary services associated with them. If a radio station has a secondary service associated with it the display will show ">>" next to the station name on the station list. The secondary service will then appear immediately after the primary service as you rotate the tuning control clockwise.
2. Press and release the **Tuning control** to select the station.
3. When the secondary service shuts down, your radio will automatically switch back to the main radio station (or primary service) if it is available.

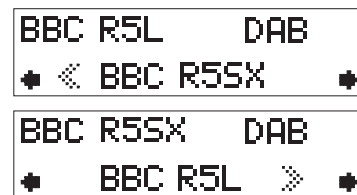
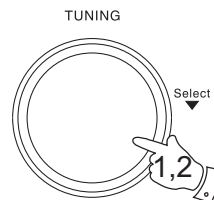

## Manual Tuning - DAB

Manual tuning allows you to tune directly to the various DAB Band III channels. UK DAB stations located in the range 11B to 12D.

1. Press and hold in the **Info button** until the display shows "Manual tune". Press and release the **Tuning control** to select this function.
2. Rotate the **Tuning control** to select the required DAB channel.
3. Press and release the **Tuning control** to select the desired channel. The graph will indicate the signal strength, and the lower line will show the name of the DAB Multiplex (group of radio stations). Any stations found will be added to the stored list in the radio.
4. Press and release the **Tuning control** to return to the normal tuning mode.

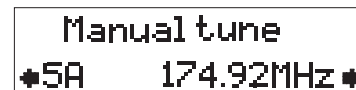
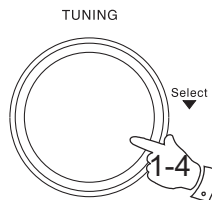
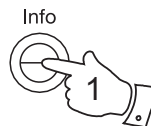

## Signal strength display - DAB

1. Repeatedly press and release the **Info button** until the lower line of the display shows signal strength.
2. Position your radio and try moving the aerial so as to give maximum number of black rectangles on signal strength display. Normally, the best reception will be found with the aerial vertical and fully extended.
3. The clear unfilled rectangle indicates minimum signal level required for satisfactory reception.

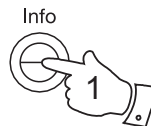

## Dynamic Range Control settings - DAB

Dynamic Range Control (also known as DRC) can make quieter sounds easier to hear when your radio is used in a noisy environment.

1. Press the **On/Off** button to switch on your radio.
2. Press and hold in the **Info** button. The display will show "Manual tune."
3. Rotate the **Tuning control** until the display shows "DRC".
4. Press and release the **Tuning control** to enter the adjustment mode.
5. Rotate the **Tuning control** to select the required DRC setting (the default is 0).
  - DRC 0 - DRC is switched off, Broadcast DRC will be ignored.
  - DRC 1/2 - DRC level is set to 1/2 that sent by broadcaster.
  - DRC 1 - DRC level is used as sent by broadcaster.
6. Press and release the **Tuning control** to confirm the setting. The display will return to normal tuning mode.

Note: Not all DAB broadcasts are able to use the DRC function. If the broadcast does not support DRC, then the DRC setting in the radio will have no effect.

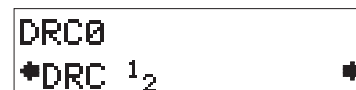
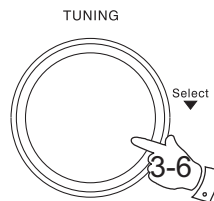
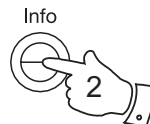

## Operating your radio - Search tuning - FM

1. Carefully extend the telescopic aerial fully.
2. Press the **On/Off button** to switch on your radio.
3. Press the **DAB/FM button** to select the FM band.
4. Press and immediately release the **Auto tune button**, your radio will scan in an upwards direction (low frequency to high frequency) and stop automatically when it finds a station of sufficient strength.
5. After a few seconds the display will update. The display will show the frequency of the signal found. If the signal is strong enough and there is RDS data present then the radio will display the station name.
6. To find other stations, press and release the **Auto tune button** as before.
7. To scan the FM band in a downwards direction (high frequency to low frequency) press and hold down the **Auto tune button** for 2 seconds and then release.
8. When the waveband end is reached your radio will recommence tuning from the opposite waveband end.
9. Adjust the **Volume control** to the required setting.

The use of radio station presets for selecting your preferred radio stations is described on page 18.

If you need any further advice, please call our Technical Helpline on :-  
020 8758 0338 (Mon-Fri)

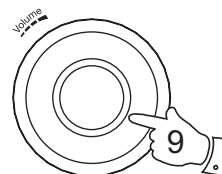
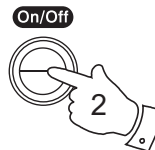

## Manual tuning - FM

1. Press the **On/Off button** to switch on your radio.
2. Press the **DAB/FM button** to select the FM band. Carefully extend the telescopic aerial fully for FM reception.
3. Rotate the **Tuning control** to tune to a station. With each click of the control the frequency will change up or down by 50 kHz.
4. When the waveband end is reached the radio will recommence tuning from the opposite waveband end.
5. Set the **Volume control** to the desired settings.
6. To switch off your radio press the **On/Off button**.

On/Off

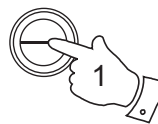

DAB/FM



TUNING

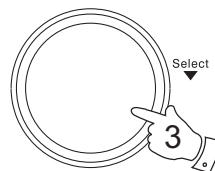

89.30MHz	FM
➡ 89.35MHz	➡

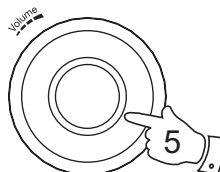

On/Off



## Display modes - FM

In FM mode the bottom line of the display can be set to any of the following display options:-

1. Press the **Info button** to cycle through each of the options.
  - a. Scrolling text                      Displays scrolling text messages such as artist/track name, phone in number etc.
  - b. Program type                         Displays type of station being listened to e.g. Pop, Classic, News, etc.
  - c. Time and date                         Displays the current time and date.
  - d. Frequency                             Displays frequency of the station being listened to.
  - e. Audio mode                            Display shows Auto (stereo) or Mono.

Note: Your radio will display "NO Radio Text" on the lower line of the display if there is no scrolling text available and "NO PTY" if there is no programme type information.

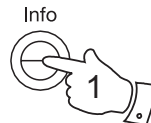

- a 

BBC R2	FM
The latest news	
- b 

BBC R2	FM
Pop Music	
- c 

BBC R2	FM
12:02 16-06-2008	
- d 

BBC R2	FM
89.30MHz	
- e 

89.30MHz	FM
Auto (Stereo)	

## Favourite button

Your radio is fitted with a button which when pressed will automatically select the required waveband and tune to your Favourite radio station. With this button you can store one favourite station from either the DAB or FM wavebands.

To set up your favourite station, follow these steps:

1. Carefully extend the telescopic aerial and switch on your radio.
2. Select the desired waveband (DAB or FM) and tune into the required radio station as described on the preceding pages.
3. Press and hold down the **Favourite button** (for 5 seconds) until the display shows "My Fav. Saved".

Favourite



BBC R7	DAB
My Fav. Saved	

## Recalling your favourite station

1. Carefully extend the telescopic aerial and switch on your radio.

If your radio is in Auxiliary Input mode, press and release the **DAB/FM button** to select normal radio operation.

2. Momentarily press the **Favourite button**, your radio will automatically select the DAB or FM waveband as needed and then tune to the radio station stored in the favourite memory.

Favourite



BBC R7	DAB
Im sorry I have	

## Preset stations - DAB and FM

To make it easier for you to tune your radio to the stations that you prefer, you may store selected radio stations as presets. Your radio holds presets separately for DAB and FM radio modes.

You may set as many or as few presets as you like in each mode.

You can easily switch between displaying all DAB stations (or all FM frequencies) and displaying only those that you have set as presets.

Any station or frequency which has been marked as a preset can easily have the mark cancelled should your preferences or needs change.

Presets are retained when your radio is switched off.

1. To setup your preset stations, tune into the required station.
2. Press and hold down the **Preset button** until the displays shows a tick symbol next to the radio station name or frequency. This indicates that the radio station is marked as a preset. To cancel the preset mark, press and hold the **Preset button** again.
3. Repeat steps 1 and 2 as needed for any other stations that you want as presets.
4. To view only the preset stations for the currently selected waveband when tuning, press and release the **Preset button** so that the heart symbol shows in the display.
5. To listen to one of the preset radio stations, rotate the **Tuning control** until the required radio station is displayed. Press and release the **Tuning control** to select and tune to that station.
6. To cancel the preset stations view, press and release the **Preset button** so that the heart symbol disappears from the display. Your radio will then be able to access the full station list using the **Tuning control**.

Preset



Classic ✓ DAB  
Classical Music

TUNING

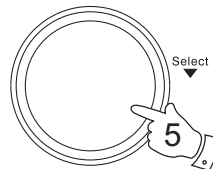

Classic ✓ DAB ♥  
Classical Music

Preset



## FM Stereo/Mono (Headphones only)

1. If a station being received is weak some hiss may be audible (especially when listening using headphones). To reduce this, press and release the **Tuning control** so that the display shows "Switch to Mono". Your radio will switch to mono mode.
2. To return to stereo mode press and release the **Tuning control** so that the display shows "Switch to Auto". Your radio will switch to stereo mode.

Note: Stereo listening is only available when listening via headphones.

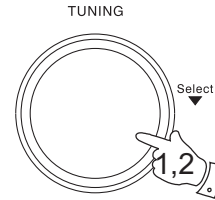

89.30MHz FM  
Switch to Mono

89.30MHz FM  
Switch to Auto

## Scan sensitivity setting - FM

Your radio will normally scan for FM broadcasts which are strong enough to give good reception. However, you may wish the Auto-scan function to also be able to find weaker signals, possibly from more distant radio transmitters. Your radio includes a local / distant option for the Auto-scan function.

1. Press the **On/Off button** to switch on your radio.
2. If needed, press the **DAB/FM button** to select the FM band.
3. Press and hold the **Info button** until the display shows "FM Scan Zone" then press the **Tuning control** to enter the scan zone selection menu.
4. Rotate the **Tuning control** to switch between Local and Distant options on the lower line of the display. The Distant option will allow the radio to find weaker signals when scanning.
5. Press and release the **Tuning control** to confirm your selection. The radio will then revert to the normal information display. The Local or Distant setting is stored in the radio and remains in force until changed or until a System Reset.

Note: The initial setting (out of the box, or after a System Reset) causes the radio to ignore weaker (or more distant) signals.

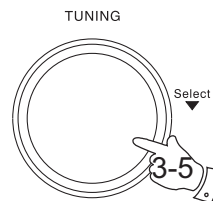
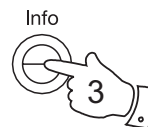
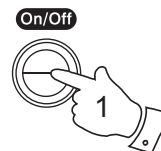

FM  
\*FM Scan Zone\*

FM Scan Zone \*  
\*Local\*

FM Scan Zone  
\*Distant\*

## Software version

The software display cannot be altered and is just for your reference.

1. To view the software version on the display, ensure your radio is in DAB mode and press and hold the **Info button** for 2 seconds.
2. Rotate the **Tuning control** until the display shows “SW Version”. Press the **Tuning control** the software version will appear on the display.
3. Press the **Info button** to revert to the normal display mode.

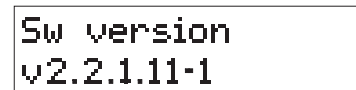
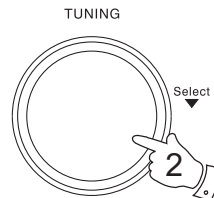
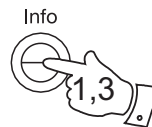

## System reset

If your radio fails to operate correctly, or some digits on the display are missing or incomplete, it may be possible to restore normal operation by carrying out a System Reset operation on your radio. This will restore the radio's settings to their factory defaults. No presets will be stored, and the list of DAB radio stations will be empty.

If you have moved to a different part of the country and you wish to erase local DAB radio stations that are no longer available from the stored list, then you may carry out this procedure. Your radio will automatically re-scan for the DAB stations available at your current location when it restarts.

1. Press and hold down the **Info button** for 2 seconds
2. Rotate the **Tuning control** until the display shows "Factory reset", then press and release the **Tuning control**.
3. If you wish to perform the reset operation, press and release the **Tuning control one more time**. A full reset of your radio will be performed. All presets and station lists will be erased.
4. After a system reset a scan of the DAB band will be performed.

In case of malfunction due to electrostatic discharge, reset the product (temporary disconnection of the power adaptor or removal of batteries may be required) to resume normal operation.

**If a problem persists our technical staff would be pleased to offer any assistance on operating the radio. Our technical helpline number is 020 8758 0338.**

*If you need any further advice, please call our Technical Helpline on :-  
020 8758 0338 (Mon-Fri)*

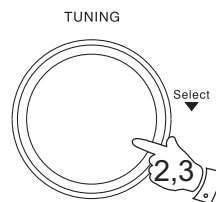
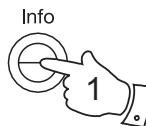

DAB  
\*Factory reset\*

Press SELECT to  
confirm reset...

Welcome to DAB  
■■■■■■■■■■

## Headphone socket

A 3.5mm **Headphone Socket** located on the right hand side of your radio is provided for use with either headphones or an earpiece. Inserting a plug automatically mutes the internal loudspeaker.

**IMPORTANT:** Excessive sound pressure from earphones and headphones can cause hearing loss.



## Auxiliary input socket

1. Connect a stereo or mono audio source (i.e. CD player, MP3 player, etc.) to the **Auxiliary input socket**.
2. Press the **On/Off button** to switch on the radio. Press and release the **DAB/FM button** until the display shows "AUX IN".

Note that the Auxiliary Input mode can only be selected when a plug is inserted in the socket.

3. Adjust the **Volume control** on your player and on the radio for comfortable listening.
4. Remove the cable from the **Auxiliary input socket** or press and release the **DAB/FM button** to cancel Auxiliary Input mode.

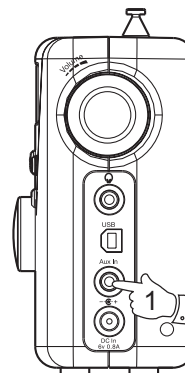

## A Few Words about Batteries...

Your Roberts solarDAB 2 radio has been designed to use a choice of power sources. You may plug it into the mains using the supplied high-efficiency adaptor, or for listening away from the mains you may use either rechargeable batteries (included) or alkaline batteries. We do not recommend the use of carbon-zinc or zinc-chloride batteries.

**It is very important that you read the advice and warnings given below.**

- 1) Whichever type of batteries you choose to use, it is very important that the battery selection switch under the cover is set to the correct type.
  - a. If no batteries are fitted, then set the switch to the Alkaline position (to the left as viewed from the back of the radio). This position minimises the power consumption when the radio is powered from the mains.
  - b. If Alkaline batteries are fitted, then set the switch to the Alkaline position (to the left as viewed from the back of the radio).
  - c. If Rechargeable batteries are fitted, then set the switch to the NiMH/NiCad position (to the right as viewed from the back of the radio). Your radio is designed to use Nickel-Metal-Hydride or Nickel Cadmium rechargeable batteries. No other type of rechargeable battery should be used in the radio.
- 2) **NEVER** mix old and new Alkaline batteries. The old batteries may suffer damage and leak which will damage your radio and whatever the radio is standing on.
- 3) **NEVER** mix old and new Rechargeable batteries. This may result in unreliable charging and shortened battery life. Never mix Rechargeable batteries of different types or capacities even if they are new.
- 4) **NEVER** mix Alkaline and Rechargeable batteries. The recharging of Alkaline batteries can be very dangerous.

## Rechargeable batteries

Your solarDAB 2 radio uses a range of methods to ensure correct and safe charging of Rechargeable Nickel-Metal-Hydride or Nickel Cadmium batteries. These work to protect your batteries from excessive charge and discharge. These protections can only work properly if the advice above is followed. In particular, the radio will not be able to correctly charge batteries if they are a mixture of different brands, or different ages, or different capacities.

We recommend that all the rechargeable batteries used in your radio are bought together as a set. They should always be charged together and discharged together and not "borrowed" from time to time for other applications. This will ensure that they give their optimum performance in your radio.

We recommend that the rechargeable batteries that you use should be from a quality brand, and should be of at least 2500mAh capacity. Batteries of this capacity should be able to power your radio for up to 20 hours depending upon the volume of the radio, whether DAB or FM mode is used (DAB mode uses slightly less power than FM), and also depending on the condition of the batteries.

Before you first install a new set of rechargeable batteries into your radio you should first make sure that the battery type switch beneath the battery cover is in the NiMH/NiCad position. Install the batteries arranging them as shown on the back of the radio. Plug the mains adaptor into a mains socket and then into the radio. While the batteries are charging the charge indicator should show a flashing green light. When the batteries are fully charged the indicator will stop flashing and will show a steady green light. The time taken to charge the batteries will depend on how much charging they require. New batteries may be partly charged when first fitted, but it is normal for a set of batteries to take several hours to charge fully (this can be between 5 and 8 hours depending on the battery capacity and their initial state of charge).

If you use the radio powered from the batteries, the battery light will be off until the batteries are exhausted. The battery light will then show red for a short while before the radio switches itself off. It does this in order that the batteries are not excessively discharged. This would otherwise damage the batteries and shorten their life.

If you use the radio powered from the mains with rechargeable batteries fitted, the charging process is suspended until you switch off the radio. When you switch off the radio using its On/Off button charging will then resume. If the batteries have already been charged then they will only charge for a few more minutes before the charge indicator stops flashing.

If you only listen to your radio for short periods, you do not need to connect your radio to the mains to charge the batteries every time that you use it. However, if the radio is not to be used for a few weeks, then we recommend that the batteries are fully charged (charge light shows steady green) before the radio is put to one side.

If you intend not to use your radio for some months, then we recommend that the batteries are removed and put away, keeping them in a cool place out of reach of children, away from moisture and such that no metal object can contact the battery terminals.

With care, rechargeable batteries can last a long time and can operate for many hundreds of charge and discharge cycles. When your rechargeable batteries can no longer power your radio adequately, please dispose of them thoughtfully.

## To avoid danger and risk of injury, please follow these guide lines

Improper use of batteries may result in leakage of fluid, overheating or explosion. Battery fluid is corrosive and may also be toxic. Battery fluid can cause skin burns, can damage the eyes, and can be harmful if swallowed.

1. Keep batteries out of the reach of children.
2. Do not heat, open, puncture, mutilate or dispose of batteries by burning.
3. Do not mix different battery types or old and new batteries. Always replace all the batteries at the same time.
4. Do not carry or store batteries such that metal objects may contact the end caps.
5. Remove batteries from the radio if they are worn out or if you are storing it for a long time.
6. Remove old or worn out batteries promptly, and recycle or dispose of them according to the regulations applicable to your location.
7. If a battery does leak, remove all batteries from the product, taking care to avoid directly touching the leaked fluid. If the fluid contacts skin or clothes wash with water immediately. Before inserting new batteries, thoroughly clean the battery compartment with a damp paper towel, or follow the battery manufacturer's advice for clean up.

## Display backlight

1. When using the radio powered from batteries, the display backlight will be switched on for approximately 12 seconds when any button is pressed.
2. When your radio is powered by the AC mains using the supplied mains adaptor the display backlight will always be on whenever the radio is switched on.

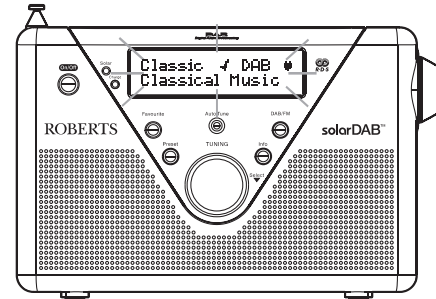

---

## USB socket for software upgrade

Software updates for your solarDAB 2 may be available in the future. If you register your product at [www.robertsradio.co.uk/register](http://www.robertsradio.co.uk/register) and include a valid e-mail address you will receive notification of software updates.

As software updates become available software and information on how to update your radio can be found at [www.robertsradio.co.uk/support](http://www.robertsradio.co.uk/support)

## General

Do not allow this radio to be exposed to water, steam or sand. Do not leave your radio where excessive heat could cause damage such as in a parked car where the heat from the sun can build up even though the outside temperature may not seem too high. It is recommended that the DAB band be used wherever possible as better results in terms of quality and freedom from interference will usually be obtained than on the FM band.

The name plate is located on the rear of your radio.

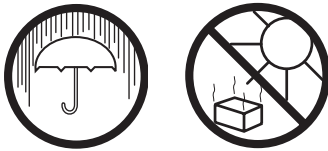

- Your radio should not be exposed to dripping or splashing and that no objects filled with liquids, such as vases, shall be placed on the radio.
- It is recommended to operate the product such that there is a minimum distance (10cm recommended) to adjacent objects in order to ensure good ventilation.
- The ventilation of the product should not be restricted by covering it or its ventilation openings with items such as newspapers, tablecloths, curtains etc.
- No naked flame sources such as lighted candles should be placed on the product.
- It is recommended to avoid using or storing the product at extremes of temperature. Avoid leaving the unit in cars in direct sunlight.

Note that normal use of the solar panel by placing the radio in the sun on a windowsill, in a conservatory or in a similar location is intended and should not harm your radio.

## Specifications

### Power Requirements

Mains	AC 100 $\sim$ 240V 50/60Hz (adaptor)
Batteries	3 x LR6 (AA size)

### Battery Life

Up to 20 hours of listening for 4 hours a day at normal volume using alkaline cells.

### Solar Power

Continuous play under adequate sunlight

### Frequency Coverage

FM	87.5-108MHz
DAB	174.928 - 239.200MHz

## Circuit Features

Loudspeaker	63mm	
Output Power	1 Watt	
Headphone socket	3.5mm dia.	
Auxiliary Input socket	3.5mm dia.	
Aerial System	FM	Telescopic aerial
	DAB	Telescopic aerial

The Company reserves the right to amend the specification without notice.

## Notes

A series of horizontal dotted lines for writing notes.

## Guarantee

This instrument is guaranteed for twelve months from the date of delivery to the original owner against failure due to faulty workmanship or component breakdown, subject to the procedure stated below. Should any component or part fail during this guarantee period it will be repaired or replaced free of charge.

The guarantee does not cover:

1. Damage resulting from incorrect use.
2. Consequential damage.
3. Receivers with removed or defaced serial numbers.

N.B. Damaged or broken telescopic aerials will not be replaced under guarantee.

Procedure:

Any claim under this guarantee should be made through the dealer from whom the instrument was purchased. It is likely that your Roberts' dealer will be able to attend to any defect quickly and efficiently, but should it be necessary the dealer will return the instrument to the company's service department for attention. In the event that it is not possible to return the instrument to the Roberts' dealer from whom it was purchased, please contact Roberts Radio Technical Services at the address shown on the rear of this manual.

*These statements do not affect the statutory rights of a consumer.*



## **ROBERTS RADIO TECHNICAL SERVICES**

97-99 Worton Road

Isleworth Middlesex

TW7 6EG

Technical Helpline :- 020 8758 0338 (*Mon-Fri during office hours*)

<http://www.robertsradio.co.uk>

© 2009 Roberts Radio Limited

