

ROBERTS

Enjoy Listening

ecologic 7

DAB / FM RDS Digital Radio with Alarm, Sleep and Nap Timer



Digital Audio Broadcasting

Please read this manual before use

Contents

<i>Controls</i>	2-3	<i>View alarm setting</i>	26
<i>Navigation</i>	4	<i>Cancelling alarm</i>	26
<i>Battery operation</i>	5	<i>Snooze</i>	26
<i>Using the radio for the first time</i>	6	<i>Sleep function</i>	27
<i>Operating your radio - DAB</i>	7	<i>Nap timer</i>	28
<i>Selecting a station - DAB</i>	8	<i>Dimmer function</i>	29-30
<i>Secondary services - DAB</i>	9	<i>Software version</i>	30
<i>Display modes - DAB</i>	10-11	<i>Auxiliary input socket</i>	31
<i>Finding new stations - DAB</i>	12	<i>Headphone socket</i>	32
<i>Manual tuning - DAB</i>	12	<i>USB socket for software upgrade</i>	32
<i>Dynamic range control (DRC) settings - DAB</i>	13	<i>Clock display</i>	32
<i>Operating your radio - FM auto tune</i>	14	<i>System reset</i>	33
<i>Manual tuning - FM</i>	15	<i>General</i>	34
<i>Display modes - FM</i>	16	<i>Specifications</i>	34
<i>Stereo/mono setting - FM</i>	17	<i>Circuit features</i>	34
<i>Presetting stations - DAB and FM</i>	18	<i>Guarantee</i>	Back page
<i>Recalling a preset station - DAB and FM</i>	19		
<i>Setting the clock manually</i>	20-21		
<i>To return to auto clock set mode</i>	22		
<i>Setting alarm time</i>	23-25		

Controls

(Top)

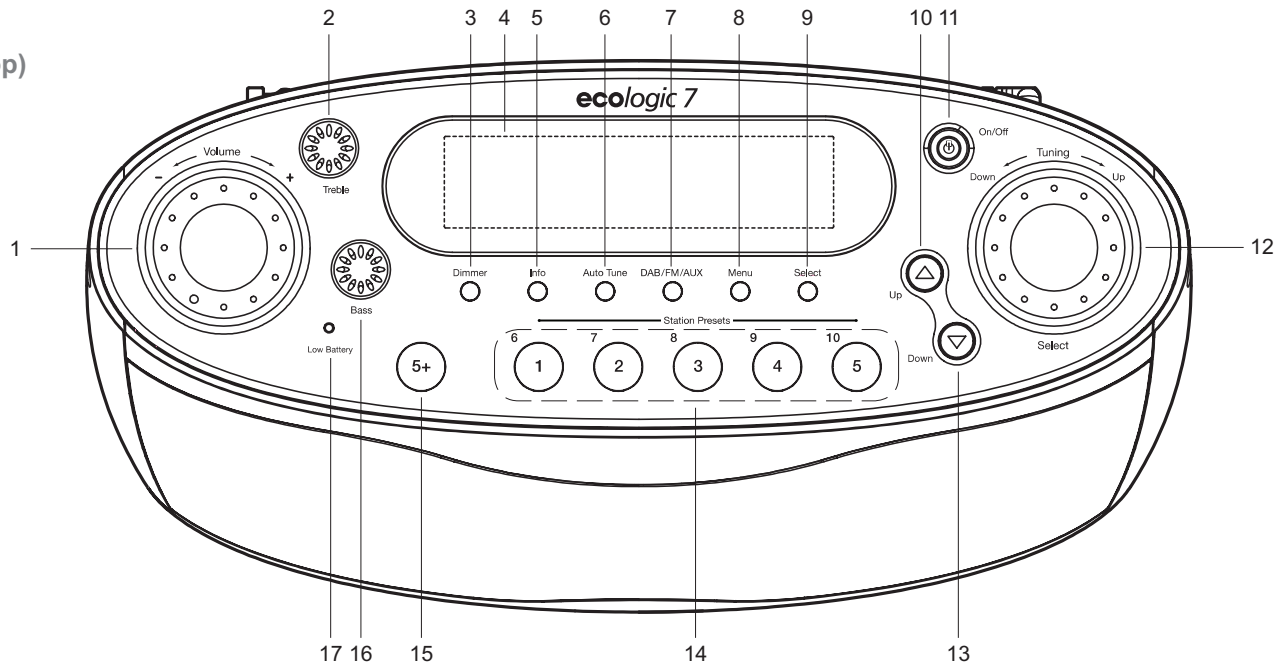

1. Volume control
2. Treble control
3. Dimmer button
4. LCD display
5. Info button
6. Auto Tune button

7. DAB / FM / AUX button
8. Menu button
9. Select button
10. Tuning Up button
11. On / Off button
12. Tuning / Select control

13. Tuning Down button
14. Station preset buttons
15. 5 + button
16. Bass control
17. Low battery indicator

Controls

(Rear View)

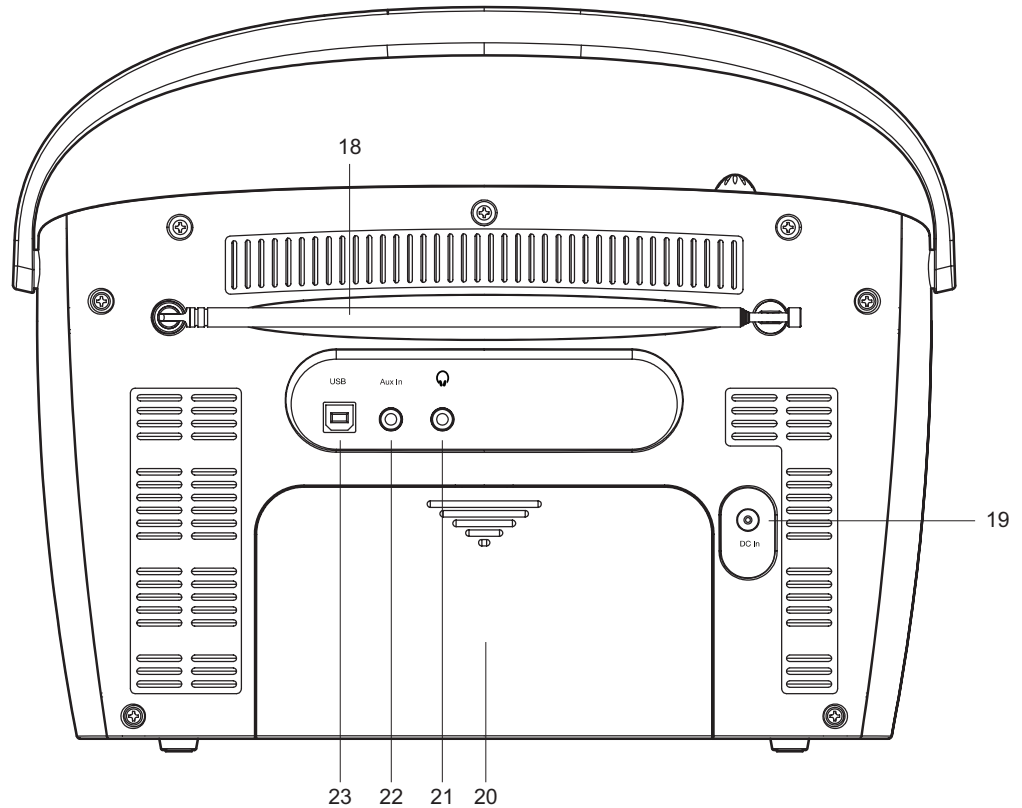

- 18. Telescopic aerial
- 19. DC in socket
- 20. Battery compartment
- 21. Headphone socket
- 22. Auxiliary input socket
- 23. USB socket (for service use only)

Navigation

This page describes the basic means of controlling your Ecologic 7. Instructions for each operating mode are given in the later sections of this book.

1. Pressing the **On/Off** button brings your radio out of Stand-by mode if running from the mains or switches it on if using batteries.

Pressing the **On/Off** button while the radio is in use will cause it to return to Stand-by mode with the clock display when running from the mains, or will switch it off when running on batteries.

2. Pressing the **DAB/FM/AUX** button gives you access to each operating mode in turn: DAB, FM and Auxiliary input.

3. Press and release the **Menu** button to access the menu system for each mode.

4. Pressing the **Menu** button once or twice as needed will access the Main radio menu allowing access to DAB, FM, Auxiliary input mode, Utility and Setup modes.

5. If an error is made when navigating the menus it is generally possible to get back to a higher level menu by pressing and releasing the **Menu** button.

6. Many operations require the user to make a selection from the menu. This is done using either the **Tuning/Select** control or **Tuning Up/Down** buttons. Turn the control clockwise or anti-clockwise to highlight the desired menu item then press the control to select that item.

Alternatively press the **Tuning Up** or **Down** buttons to highlight the desired menu item then press the **Select** button to select that item.

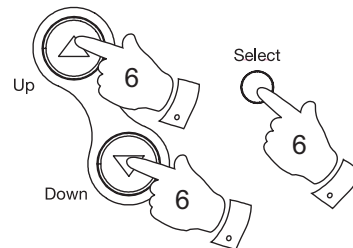
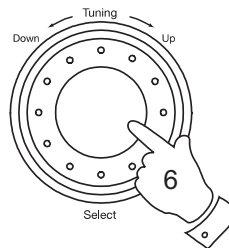
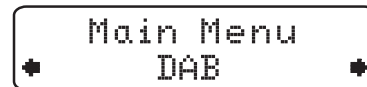
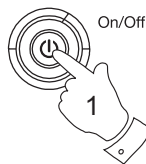

Battery operation

1. Remove the **Battery cover** on the rear of the unit by pushing the battery door in and downwards.
2. Insert six LR20 (D size) batteries into the spaces in the compartment. Take care to ensure all batteries are inserted with the correct polarity as shown next to the battery compartment. Replace the battery cover.
3. The low battery indicator lighting, reduced power, a stuttering sound, distortion or the radio switching itself off are all signs that the batteries may need replacing.
4. If the radio is not to be used for any extended period of time it is recommended that the batteries are removed from the radio.

We would recommend for economy that the ecologic 7 is used via the AC adaptor whenever possible with battery operation for occasional use only. Inserting the adaptor plug into the DC input socket will disconnect the batteries.

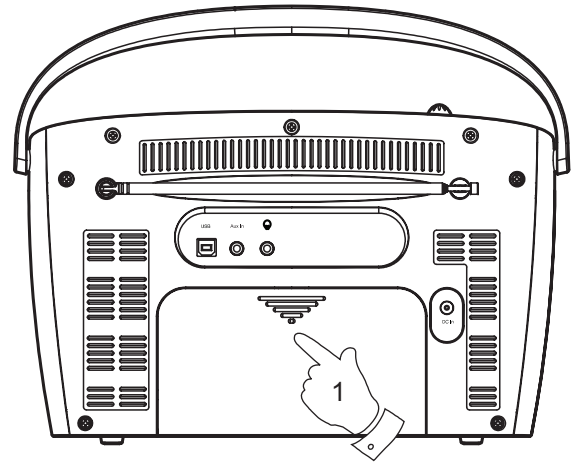

If using batteries, only alkaline types should normally be used. Battery life will vary according to the use of the radio, but up to 150 hours should be possible depending upon mode, volume, dimmer and tone settings.

Rechargeable Nickel Metal Hydride (NiMH) cells can be used in the radio but must be charged outside the radio using an external charger. Note that commercially available D size NiMH cells have a capacity which is only a small fraction of that of D size Alkaline cells and so they will power the radio for only a few hours before needing recharging. *Never mix batteries of different types, capacities or brands in the radio.*

IMPORTANT: *The batteries should not be exposed to excessive heat such as sunshine, fire or the like. After use, disposable batteries should if possible be taken to a suitable recycling centre. On no account should batteries be disposed of by incineration.*

Using the radio for the first time

1. Place your radio on a flat surface.
2. Fully extend the telescopic aerial. The aerial should be fully extended and positioned vertically for optimum reception.
3. Plug the cable from the mains adaptor into the **DC input socket** on the rear of your radio (marked 'DC In') ensuring that the plug is pushed fully into the socket. Plug the mains adaptor into a wall socket and switch on the socket. The display will show "ROBERTS RADIO" for a few seconds and then the display will then show "SET CLOCK". During this time the radio is scanning to find out which DAB radio stations are available. When stations have been found the current time and date will appear on the display.

Note that the display will not show any scanning message for this first scan.

4. If no stations are found the display will show the default time and date. It may be necessary to relocate your radio to a position giving better reception. You should then carry out a scan to find stations as described on page 12.

IMPORTANT: The mains adaptor is used as the means of connecting the radio to the mains supply. The mains socket used for the radio must remain accessible during normal use. In order to disconnect the radio from the mains, the mains adaptor should be removed from the mains socket outlet completely.

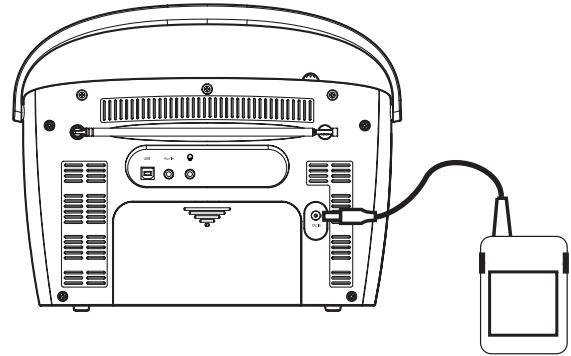

ROBERTS RADIO
Enjoy Listening

SET CLOCK

09:30
28-04-2010

Operating your radio - DAB

1. Press the **On/Off** button to switch on your radio. The display will show "Now tuning" for a few seconds.

When first switched on, the radio will be in DAB mode. After each use the radio will remember the mode used and then switch on in that mode the next time it is used.

2. If the radio has been used before, the last used station will be selected.
3. If this is the first time that the radio has been used, then the first station in the list of stations found during scanning will be played. The display will show the station name.
4. If no signals are found then "Station not available" will be displayed and it may be necessary to relocate your radio to a position giving better reception. You should then carry out a scan to find stations as described on page 12.

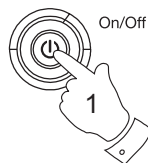

Arrow DAB
Now tuning...

Arrow DAB
Rock Music

Station not
available

Selecting a station - DAB

1. Press the **On/Off** button to switch on your radio.
2. Press the **DAB/FM/AUX** button to select DAB mode. The display will show "Now tuning" for a few seconds followed by the name of the radio station.
3. Rotate the **Tuning/Select** control to scroll through the list of available stations.
4. When the station name appears on the display, press and release the **Tuning/Select** control to select the station. The display will show "Now tuning" while your radio finds the new station.
5. Adjust the **Volume** and **Tone** controls to the required settings.

Note: If after selecting a station the display shows "Station not available" it may be necessary to relocate your radio to a position giving better reception.

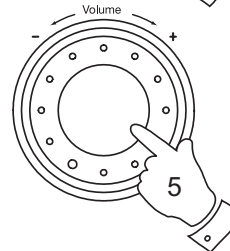
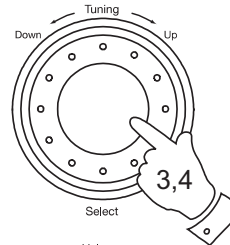

BBC R2 DAB
Now Playing: Hey

PlntRock DAB
Now tuning...

PlntRock DAB
Now playing 'Love

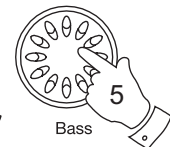
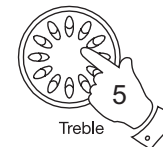

Secondary services - DAB

1. Certain radio stations have one or more secondary services associated with them. If a station has a secondary service associated with it the display will show ">>" next to the station name on the station list. The secondary service will then appear immediately after the primary service as you rotate the **Tuning/Select** control.
2. To tune to the secondary service, press and release the **Tuning/Select** control. Most secondary services do not broadcast continually and if the selected service is not available, the radio will retune to the associated primary service.

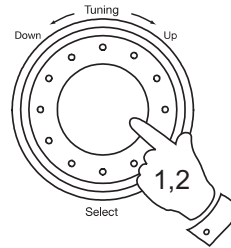

Display modes - DAB

Your radio has a range of display options when in DAB mode:-

1. Press and release the **Info** button to cycle through the various options.

a. Scrolling text Displays scrolling text messages such as artist/track name, phone in number etc.

b. Program Type Displays the type of station being listened to e.g. Pop, Classic, News etc.

c. Multiplex Name Displays the name of DAB multiplex to which the current station belongs.

d. Frequency Displays the frequency for the currently tuned DAB station.



a

BBC R2	DAB
News on the hour	

b

BBC R2	DAB
News	

c

BBC R2	DAB
BBC National	DAB

d

BBC R2	DAB
12B	225.64MHz

Display modes - DAB cont.

e. Bit rate & audio type Displays the digital bit rate & audio type for the current DAB radio station.



f. Signal strength Displays the signal strength for the station being listened to. The clear rectangle shows the minimum required signal strength for clear DAB reception.



g. Time Displays the current time.

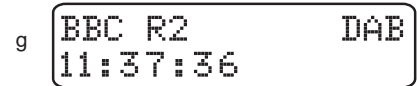

h. Date Displays the current date.

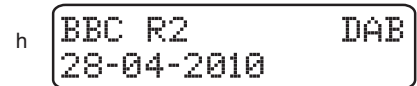

Finding new stations - DAB

As time passes new stations may become available. To find new stations proceed as follows:-

1. With the unit in DAB mode (see page 8) press and release the **Auto Tune** button, the display will show "Scanning". Your radio will perform a scan of the Band III DAB channels. As new stations are found the station counter on the right-hand side of the display will increase and stations will be added to the list.

Auto Tune



Manual Tuning - DAB

Manual tuning allows you to tune directly to the various Band III DAB channels. UK DAB stations are currently located in the range 11B to 12D.

1. Press and release the **Menu** button so that the display shows "Manual tune". Press and release the **Tuning/Select** control.
2. Rotate the **Tuning/Select** control to select the required DAB channel.
3. Press and release the **Tuning/Select** control. The open block in the signal strength graph shows you the minimum signal strength needed for good DAB reception. The signal blocks will go up and down showing the changing signal strength as you adjust the telescopic aerial or the radio position. Any new radio stations found on the tuned DAB multiplex will be added to the list stored in the radio.
4. Press and release the **Tuning/Select** control to return to normal tuning mode.

Menu

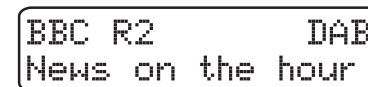
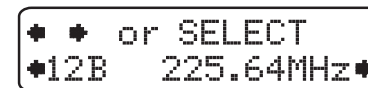
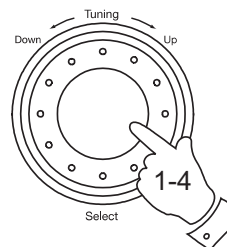

Dynamic Range Control (DRC) settings - DAB

DRC can make quieter sounds easier to hear when your radio is used in a noisy environment. This function is only for the DAB waveband.

1. Press the **On/Off** button to switch on your radio.
2. Press and release the **Menu** button so that "Manual tune" appears on the display.
3. Rotate the **Tuning/Select** control until the display shows "DRC value". Press and release the **Tuning/Select** control to enter the DRC adjustment mode.
4. Rotate the **Tuning/Select** control to select the required DRC setting (default is 0).

DRC 0 DRC is switched off, Broadcast DRC will be ignored.

DRC 1/2 DRC level is set to 1/2 that sent by broadcaster.

DRC 1 DRC is set as sent by broadcaster.

5. Press and release the **Tuning/Select** control to confirm the setting. The display will return to normal tuning mode.

Note: Not all DAB broadcasts are able to use the DRC function. If the broadcast does not support DRC, then the DRC setting in the radio will have no effect.

Menu

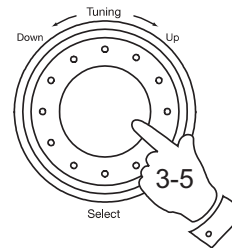

◆ ◆ or SELECT
◆Manual tune◆

◆ ◆ or SELECT
◆DRC value◆

DRC 0
◆DRC 0◆

DRC 0
◆DRC 1/2◆

DRC 0
◆DRC 1◆

Operating your radio - FM auto tune

1. Carefully extend the telescopic aerial fully and press the **On/Off** button to switch on your radio.
2. Press and release the **DAB/FM/AUX** button to select the FM band.
3. Press and release the **Auto Tune** button to cause your radio to scan in the direction previously scanned and stop automatically when it finds a station of sufficient strength.
4. After a few seconds the display will update. The display will show the frequency of the signal found. If the signal is strong enough and there is RDS data present then the radio will display the station name.
5. To find additional stations press and release the **Auto Tune** button as before.
6. To scan the FM band in a opposite direction either rotate the **Tuning/Select** control clockwise or use **Tuning Up** button (to scan low frequency to high frequency) or rotate anti-clockwise or use **Tuning Down** button (to scan high frequency to low frequency) and then press the **Auto Tune** button again.
7. When the end of the waveband is reached your radio will recommence tuning from the opposite end of the waveband.
8. Adjust the **Volume** and **Tone** controls to the required settings.
9. To switch off your radio press the **On/Off** button.

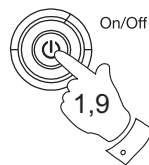

DAB/FM/AUX



Auto Tune

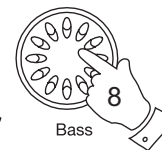
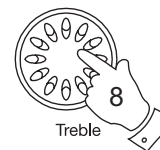
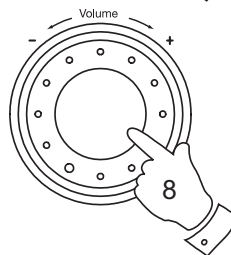
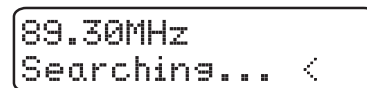
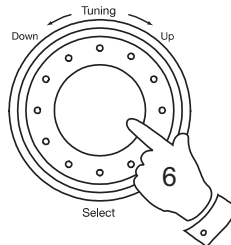
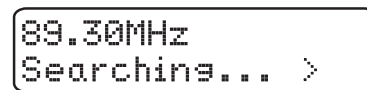

If you find that an FM broadcast has a lot of background hiss, this may often be reduced by setting the radio into Mono reception mode for the current FM station. Please refer to the section "Stereo / Mono setting - FM" on page 17 for further details.

Manual tuning - FM

1. Fully extend the Telescopic aerial and press the **On/Off** button on your radio.
2. Press and release the **DAB/FM/AUX** button to select the FM band.
3. Rotate the **Tuning/Select** control or press the **Tuning Up** or **Down** buttons to tune to a station. The frequency will change in steps of 50kHz.
4. When the end of the waveband is reached the radio will recommence tuning from the opposite end of the waveband.
5. Set the **Volume** and **Tone** controls to the desired settings.
6. To switch off your radio press the **On/Off** button.

If you find that an FM broadcast has a lot of background hiss, this may often be reduced by setting the radio into Mono reception mode for the current FM station. Please refer to the section "Stereo / Mono setting - FM" on page 17 for further details.

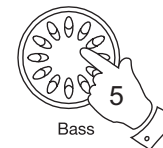
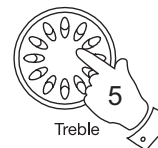
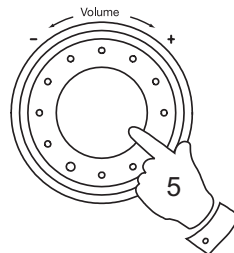
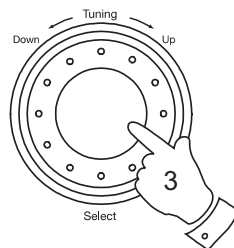
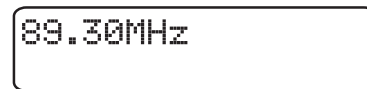

Display modes - FM

Your radio has a range of display options for FM mode:-

The Radio Data System (RDS) is a system in which inaudible digital information is transmitted in addition to the normal FM radio programme. RDS offers several useful features. The following are available on your radio.

1. Press and release the **Info** button to cycle through the various modes.

- | | |
|-------------------|--|
| a. Scrolling text | Displays scrolling text messages such as artist/track name, phone in number etc. |
| b. Program Type | Displays type of station being listened to e.g. Pop, Classic, News etc. |
| c. Time | Displays the current time.
(24 hour clock format) |
| d. Date | Displays the current date. |
| e. Frequency | Displays frequency of the fm signal |

Note: If no RDS information is available, the radio will be unable to display the station name, scrolling text and programme type information.



a

BBC R2	st
The latest new	

b

BBC R2	st
News	

c

BBC R2	st
11:37:36	

d

BBC R2	st
28-04-2010	

e

BBC R2	st
87.50MHz	

Stereo / Mono setting - FM

Your radio will play stereo FM broadcasts in stereo provided that the received signal is of adequate strength. However, as a stereo signal becomes weaker the audio signal will become poorer. It may be preferable to force the radio to play the station in mono in order to reduce the level of background hiss.

1. Press the **On/Off** button to switch on your radio.
2. Tune to the required FM radio station as previously described (see pages 14, 15).
3. Press the **Menu** button and rotate the **Tuning/Select** control until "Mono" shows on the display. Press the **Tuning/Select** control to cause the radio station to play the current station in mono.

The Mono override is a temporary setting and is applied to the currently tuned station only. It is cancelled automatically by tuning to another station.

4. If you wish to cancel the Mono override while listening to the currently tuned radio station, press the **Menu** button and rotate **Tuning/Select** control until "Auto" shows on the display. Press the **Tuning/Select** control to cause the radio to play the current station in stereo if the signal is sufficiently strong.

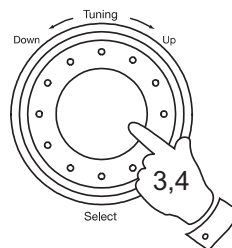
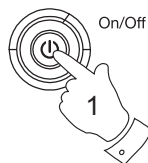

Presetting stations - DAB and FM

You may store your preferred DAB and FM radio stations to the preset station memories. There are 20 memory presets in your radio 10 for DAB and 10 for FM. Presets are remembered by your radio in the event of a power failure.

The procedure for setting presets and using them to tune stations is the same for FM and DAB modes, and is described below.

1. Press the **On/Off** button to switch on the radio.
2. Press the **DAB/FM/AUX** button to select the DAB or FM waveband.
3. Tune to the required station as previously described.
4. Press and hold down the required **Preset** button until the display shows, for example "Preset 01 Saved". The currently tuned station will be stored under the chosen preset button. Repeat this procedure for the remaining presets.
5. Presets 6 to 10 are obtained by pressing and holding **5+** button together with the **Preset** button **1 to 5**. e.g preset 7 can be set by pressing and holding **5+** button together with **Preset** button **2** until the display shows "Preset 07 Saved".
6. Stations stored in preset memories may be overwritten by following the above procedure.

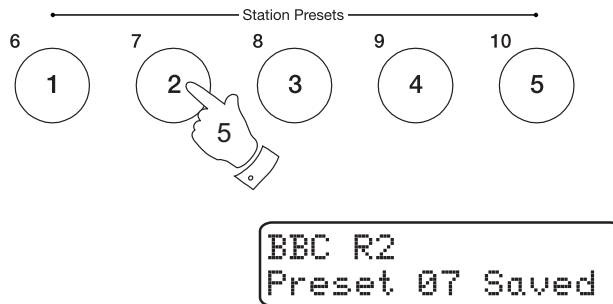
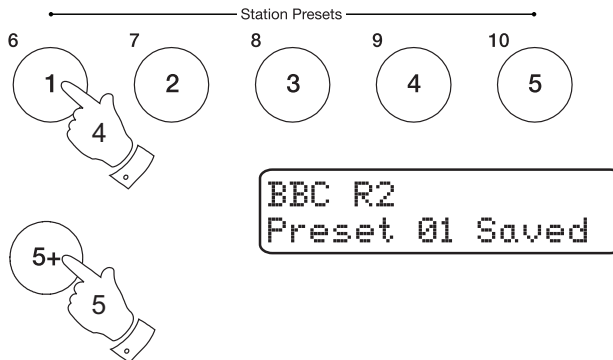
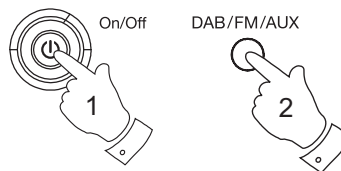

Recalling a preset station - DAB and FM

1. Press the **On/Off** button to switch on the radio.
2. Select the required waveband by pressing the **DAB/FM/AUX** button.
3. Momentarily press and release the required **Preset** button. The display will show, for example, "Empty preset" if no station has been stored to that preset. If a preset has been stored, then the display will show for example "Preset 01 Loaded".
4. Presets 6 to 10 are obtained by pressing and holding **5+** button and holding **Preset** button **1 to 5**. e.g preset 7 can be recalled by pressing and holding **5+** button followed by pressing **Preset** button **2**, then releasing both buttons.
5. Your radio will then tune to the chosen preset station stored in the preset memory.

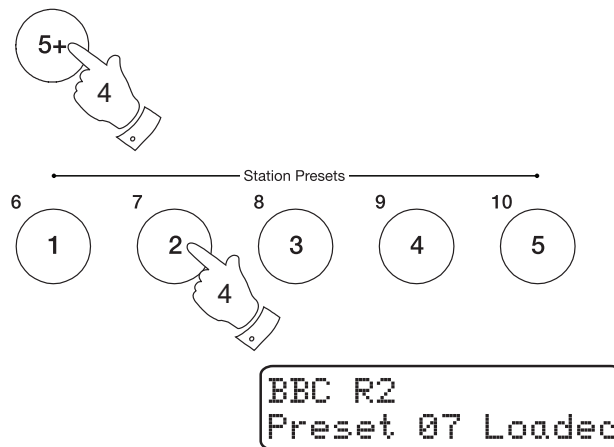
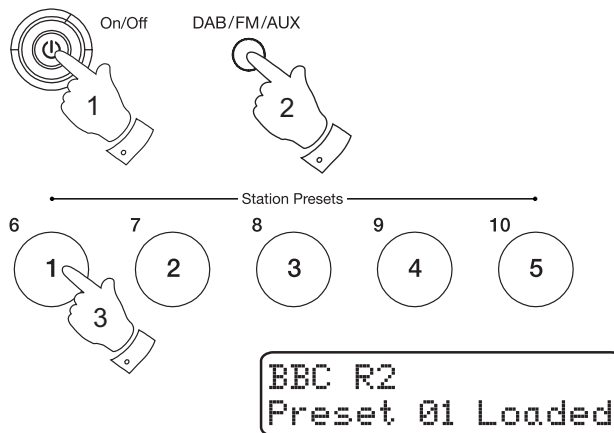

Setting the clock manually

Normally your radio will set its clock automatically using the DAB radio signal. If no DAB signal is available and you need to set the time manually, please follow the procedure shown below.

1. Press the **On/Off** button to switch on the radio.
2. To set the clock time, press the **Menu** button once or twice as needed until "Main Menu" appears on the display. Rotate the **Tuning/Select** control until "Set up" shows on the display.
3. Press and release the **Tuning/Select** control to enter the Set up menu and rotate until "Clock" appears on the display. Press and release the **Tuning/Select** control to enter clock setup.
4. Rotate the **Tuning/Select** control until "Manual clock" appears on the display.
5. Press and release the **Tuning/Select** control to enter the manual setting procedure. The hour digits will flash on the display.
6. Rotate the **Tuning/Select** control to set the desired hour.
7. Press and release the **Tuning/Select** control to enter the hour setting. The minute digits will then flash on the display.
8. Rotate the **Tuning/Select** control to set the desired minute.

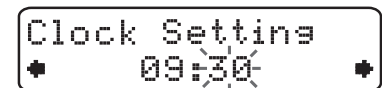
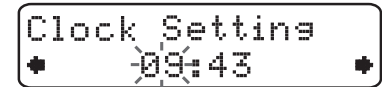
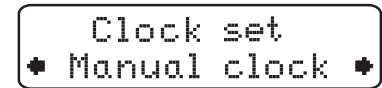
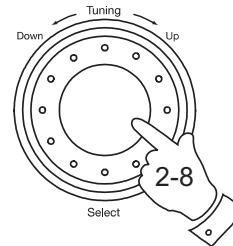

9. Press and release the **Tuning/Select** control to enter the minutes setting. The day of the month will then flash on the display.
10. Rotate the **Tuning/Select** control to change the day as needed.
11. Press and release the **Tuning/Select** control to enter the day setting. The month will then flash on the display.
12. Rotate the **Tuning/Select** control to select the correct month.
13. Press and release the **Tuning/Select** control to enter the month setting. The year will then flash on the display.
14. Rotate the **Tuning/Select** control to select the current year.
15. Press and release the **Tuning/Select** control to confirm the clock setting and return to the normal radio display.

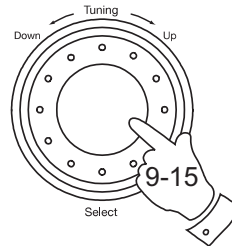

To return to auto clock set mode

1. Press the **On/Off** button to switch on the radio. If necessary press and release the **DAB/FM/AUX** button to put the radio into DAB mode.
2. Press the **Menu** button once or twice as needed until "Main Menu" appears on the display. Rotate the **Tuning/Select** control until "Set up" shows on the display.
3. Press and release the **Tuning/Select** control to enter the Set up menu and rotate until "Clock" appears on the display. Press and release the **Tuning/Select** control to enter clock setup.
4. Rotate the **Tuning/Select** control until "Auto clock" appears on the display.
5. Press and release the **Tuning/Select** control.
6. The radio will immediately set its time according to the information received with the DAB broadcast. The radio will return to normal radio operation.

Note: If you select "Auto clock" and no DAB signal is found, you should either position the radio or its aerial so that a signal can be received, or revert to manual clock mode (see page 20).

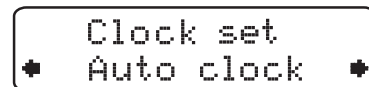
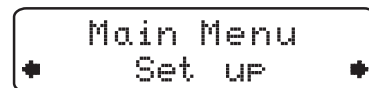
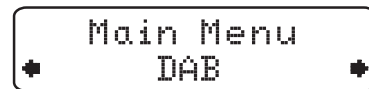
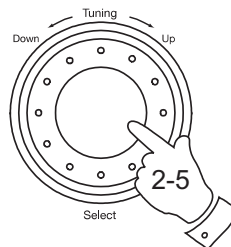
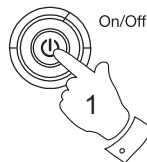

Setting alarm time

Your radio has an alarm which can be set to wake you to DAB, FM radio or beep type alarm. The alarm can be set to sound on Weekdays, Weekends, Daily or Once. **The alarm can be set when your radio is switched on or in stand-by mode.** In the event of a power interruption your radio has a built in memory that will retain your alarm settings. The alarm feature should only be used when the radio is powered from the mains. The radio's clock does not operate when the radio is in standby and powered solely from its batteries.

Note: If no buttons are pressed for 5 seconds, your radio will exit the alarm setup.

1. Press the **On/Off** button to switch on the radio if required.
2. Press the **Menu** button once or twice as needed until "Main Menu" appears on the display. Rotate the **Tuning/Select** control until "Utility" shows on the display.
3. Press and release the **Tuning/Select** control to enter the Utility menu and rotate until "Alarm" appears on the display. Press and release the **Tuning/Select** control to enter alarm setup.
4. Rotate the **Tuning/Select** control to select On or OFF. If OFF is selected any current setting for that alarm will be cancelled.
5. Choose the "On" setting then press and release the **Tuning/Select** control the hour digits will flash on the display.
6. Rotate the **Tuning/Select** control to set the desired alarm hour.
7. Press and release the **Tuning/Select** control to enter the hour setting. The minute digits will then flash on the display.

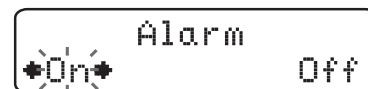
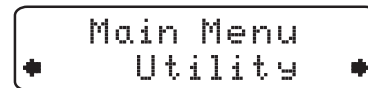
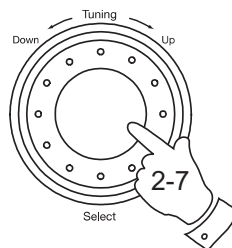
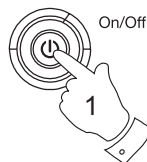

8. Rotate the **Tuning/Select** control to set the desired minute.
9. Press and release the **Tuning/Select** control to enter the minutes setting. The alarm day option will flash on the display.
10. Rotate the **Tuning/Select** control to choose the desired alarm day option.

Weekdays	- Will sound only on weekdays
Weekends	- Will sound only on weekends
Daily	- Will sound everyday
Once	- Will sound at one time only

 - If setting the alarm to once only, continue with step 11 below. Otherwise skip to 17 on the following page.
11. Press and release the **Tuning/Select** control to enter the setting. The alarm day will flash on the display.
12. Rotate the **Tuning/Select** control to choose the desired alarm day of the month.
13. Press and release the **Tuning/Select** control to enter the day setting. The alarm month will flash on the display.
14. Rotate the **Tuning/Select** control to choose the desired alarm month.
15. Press and release the **Tuning/Select** control to enter the month setting. The alarm year will flash on the display.
16. Rotate the **Tuning/Select** control to choose the desired alarm year.

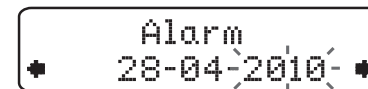
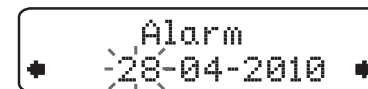
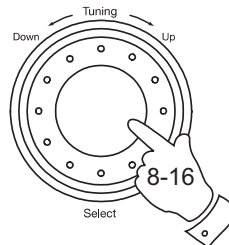

17. Press and release the **Tuning/Select** control to enter the setting. The alarm source option will flash on the display.

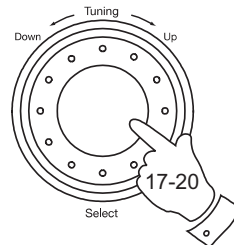

18. The alarm can be set to DAB, FM or buzzer. For whichever radio mode is selected, the radio alarm may be set to any of the stations which have been stored as presets or to the last station listened to.

Rotate the **Tuning/Select** control to highlight either 'Buzzer' or the required radio mode. Press the control to confirm the selection.



19. If setting the alarm to a radio option, rotate the **Tuning/Select** control to highlight the desired "preset 1 -10" or rotate until "Last played" is selected. Press and release the **Tuning/Select** control.

Note that you can only set the alarm to use a preset which has already been stored.

20. In order to store the alarm settings you will need to save the settings. Rotate the **Tuning/Select** control until "Yes" is highlighted on the display. Press the **Tuning/Select** control to confirm alarm settings and return to normal radio mode.

If you decide not to save the settings, highlight "No" and then press the control your radio will return to normal radio mode without saving the setting.

Note: If you make a mistake at any point while setting the alarm, press the **Menu** button to go back to the previous screen.

The radio alarm is indicated in the display by the  symbol and the buzzer alarm is indicated by the  symbol when in stand-by. When your radio is set to wake by the radio alarm, your radio will switch to either the selected preset station or last listened. Be sure to set the volume to a suitable level if using DAB or FM options.

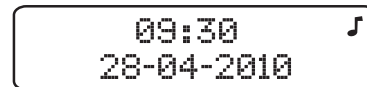
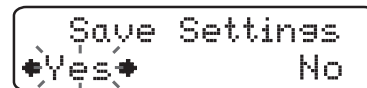
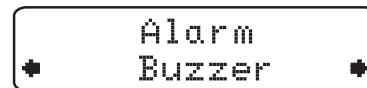

To view alarm setting

1. To view the alarm setting follows step 1-5 on page 23. Press the **Tuning/Select** control or the **Select** button to cycle through each of the settings for the chosen alarm.
2. You may rotate the **Tuning/Select** control or press the **Tuning Up/Down** buttons to modify any particular setting if desired, pressing the **Tuning/Select** control or the **Select** button to enter the modification.

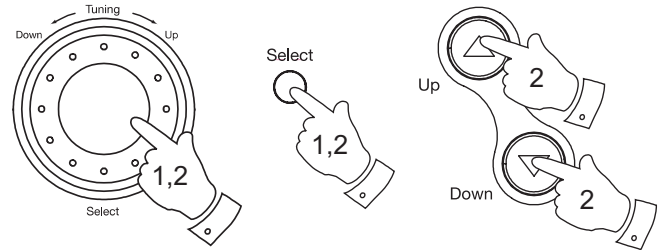

Cancelling alarm

The buzzer or radio alarm will sound at the selected times for up to 60 minutes unless cancelled. If the radio cannot connect to the specified radio station, the buzzer will be used instead.

1. When the alarm is sounding press the **On/Off** button to cancel an alarm and return to stand-by mode.
2. To cancel at any other time, enter the alarm setup menu and set the alarm On/Off option to "Off". See steps 1-4 page 23.



Snooze

1. The buzzer or radio alarm can be silenced for 9 minutes by pressing the **Tuning/Select** control or the **Select** button. When the Snooze function has been activated during an alarm, the alarm symbol will flash on the display. This sequence can be repeated during the 60 minute alarm period.
2. In order to cancel the Snooze timer while the alarm is suspended, press the **On/Off** button.

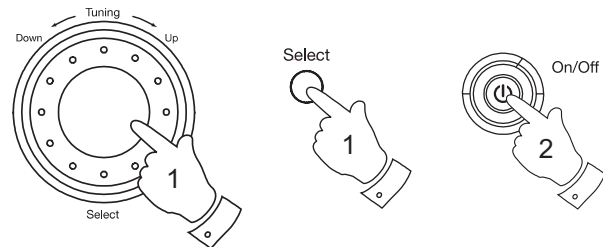

Sleep function

Your radio can be set to turn off after a preset time has elapsed. The sleep setting can be adjusted between 5 and 120 minutes in 5 minute increments.

1. Press the **On/Off** button to switch on the radio.
2. Press the **Menu** button once or twice as needed until "Main Menu" appears on the display. Rotate the **Tuning/Select** control until "Utility" shows on the display.
3. Press and release the **Tuning/Select** control to enter the Utility menu and rotate until "Sleep" appears on the display. Press and release the **Tuning/Select** control to enter sleep setup.
4. Rotate the **Tuning/Select** control until the required sleep time setting is selected. Press **Tuning/Select** control to confirm the setting. The sleep timer can be set to between 5 and 120 minutes, or to Off.
5. Your radio will switch into stand-by mode after the preset time has elapsed. If running on batteries it will switch off completely shortly afterwards.
6. To cancel the sleep time before the preset time has elapsed and to turn off the radio, press the **On/Off** button to turn the unit off manually.
To cancel the sleep timer and leave the radio playing, go back into the sleep timer settings (steps 1-4 above) and select the Off option in step 4. Alternatively, simply press the **On/Off** button twice in succession to cancel the timer and switch the radio back on again.

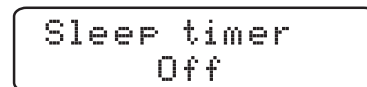
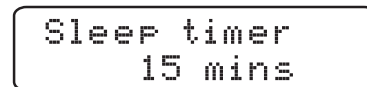
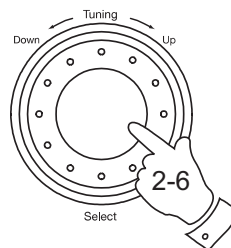
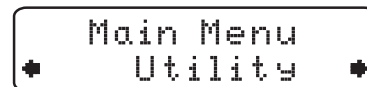
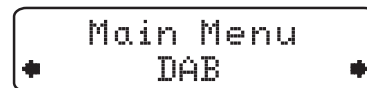

Nap timer

The Nap timer facility allows you to set your radio to wake you after a predetermined interval (up to 2 hours) without needing to set the alarm. The nap timer can be set when your radio is switched on or in stand-by mode. The nap timer should only be used when the radio is powered from the mains. The radio's clock does not operate when the radio is in standby and powered solely from its batteries.

1. Press the **On/Off** button to switch on the radio if required.
2. Press the **Menu** button once or twice as needed until "Main Menu" appears on the display. Rotate the **Tuning/Select** control until "Utility" shows on the display.
3. Press and release the **Tuning/Select** control to enter the Utility menu and rotate until "Nap" appears on the display. Press and release the **Tuning/Select** control to enter Nap timer setup.
4. Rotate the **Tuning/Select** control until the required Nap time setting is selected. Press **Tuning/Select** control to confirm the setting. The Nap timer can be set to between 5 and 120 minutes (in 5 minute increments) or to Off.
5. The Nap Timer indicator  will show on the display when in stand-by mode. When the selected Nap timer has elapsed, the buzzer will sound.
6. To cancel the buzzer press the **On/Off** button. To disable the Nap timer go back into the Nap timer settings (steps 1 to 4 above) and select the Off option in step 4.

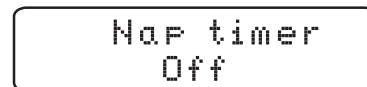
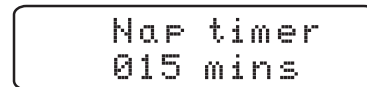
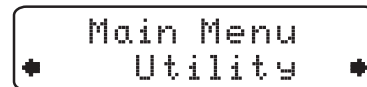
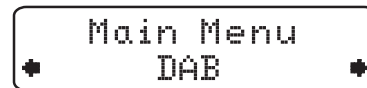
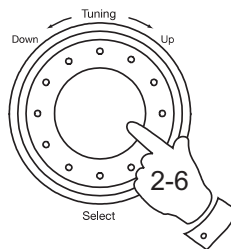

Dimmer function

The brightness of the display can be adjusted for when the radio is in Stand-by and for when it is in use. If you use the unit in a bedroom, you may prefer a lower stand-by brightness level than the standard setting. The dimmer can be set to low, mid, high and an almost off 'night time' setting.

1. Press the **On/Off** button to switch on the radio.
2. Press the **Menu** button once or twice as needed until "Main Menu" appears on the display. Rotate the **Tuning/Select** control until "Set up" shows on the display.
3. Press and release the **Tuning/Select** control to enter the Set up menu and rotate until "Dimmer" appears on the display. Press and release the **Tuning/Select** control to enter dimmer setup.
4. To adjust the display brightness when the radio is switched on rotate the **Tuning/Select** control until "Active mode" is highlighted on the display.
To adjust the display brightness when the radio is in stand-by rotate the **Tuning/Select** control until "Standby mode" is highlighted.
Press the control to enter the selected brightness adjustment mode.
5. To adjust the brightness level rotate the **Tuning/Select** control.
6. The backlight level will change as the control is rotated so that you can see the effect of each setting. Note that the backlight is almost completely off at zero setting. Press the **Tuning/Select** control to set the level.

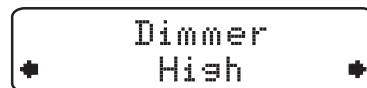
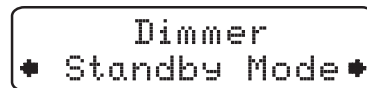
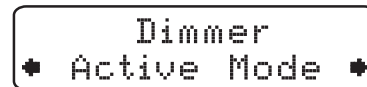
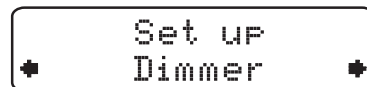
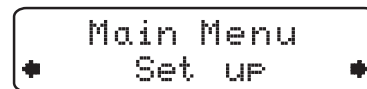
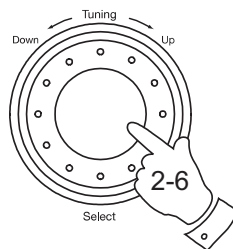
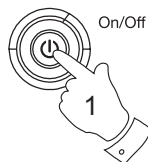

- Alternatively you can press the **Dimmer** button on your radio to select the dimmer brightness from low, mid, high and an almost off 'night time' setting.

When the radio is in Stand-by mode, pressing a button or turning the rotary control will cause the radio to switch to the normal brightness level for a few seconds. This is so that even if the Stand-by brightness level is set to zero (almost off), it is still possible to see the time by quickly pressing a button.



Software version

The software display cannot be altered and is just for your reference.

- Press the **On/Off** button to switch on the radio.
- Press the **Menu** button once or twice as needed until "Main Menu" appears on the display. Rotate the **Tuning/Select** control until "Set up" shows on the display.
- Press the **Tuning/Select** control to enter the Set up menu and rotate until "Version" appears on the display. Press and release the **Tuning/Select** control the display will show the radio software information.
- After a few seconds your radio will return to the normal radio display mode.

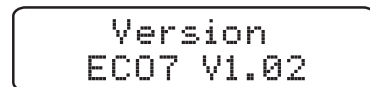
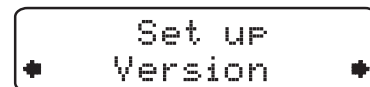
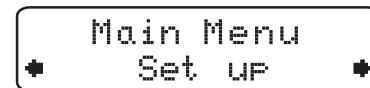
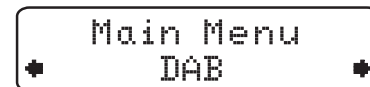
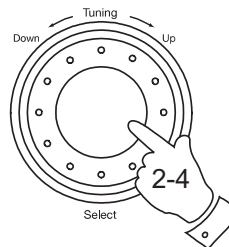

Auxiliary input socket

1. Connect a stereo or mono audio source (i.e. CD player, MP3 player, etc.) to the **Auxiliary input** socket.
2. Press the **On/Off** button to switch on the radio.
3. Press and release the **DAB/FM/AUX** button until the display shows "AUX".
4. Adjust the **Volume control** on your player and on the radio for comfortable listening.
5. Remove the cable from the **Auxiliary input** socket or press and release the **DAB/FM/AUX** button to cancel Auxiliary Input mode.



DAB/FM/AUX

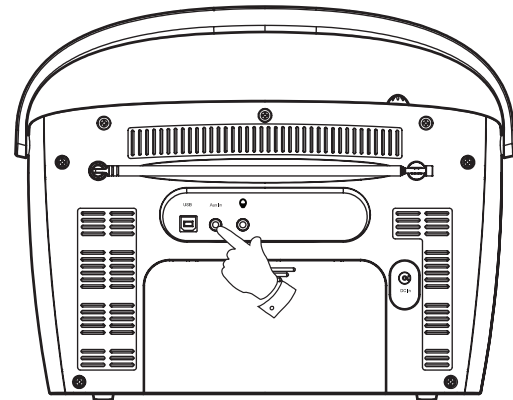

Headphone socket

A 3.5mm **Headphone Socket** located on the rear of your radio is provided for use with either headphones or an earpiece. Inserting a plug automatically mutes the internal loudspeaker.

Please be aware that sensitivity of headphones can vary widely. We therefore recommend setting volume to a low level before connecting headphones in the radio.

IMPORTANT: Excessive sound pressure from earphones and headphones can cause hearing loss.

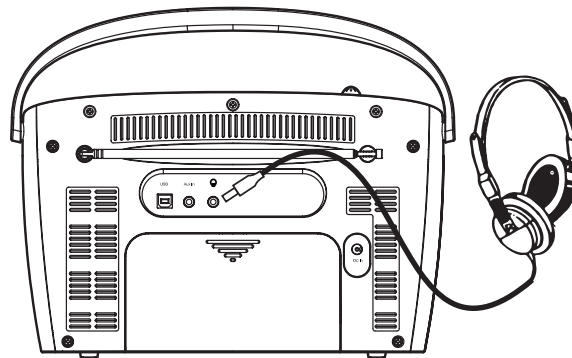

USB socket for software upgrade

A USB socket is provided at the rear of your radio for service use only to permit the possibility of updates to the internal software in the future.

If you register your product at www.robertsradio.co.uk/register and include a valid e-mail address you will receive notification of software updates.

Clock display

When your radio is in Stand-by mode (when running from the mains) the time and date will be displayed. The time is always shown using a 24 hour clock format. When running the radio on batteries, the clock display may sometimes be shown when the radio is put into standby, before the radio switches off completely.

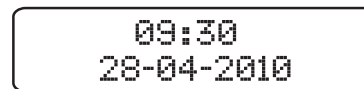

System reset

If your radio fails to operate correctly, or some digits on the display are missing or incomplete carry out the following procedure.

1. Press the **On/Off** button to switch on the radio.
2. Press the **Menu** button once or twice as needed until "Main Menu" appears on the display. Rotate the **Tuning/Select** control until "Set up" shows on the display.
3. Press the **Tuning/Select** control to enter the Set up menu and rotate until "Factory Reset" appears on the display. Press and release the **Tuning/Select** control. Rotate the **Tuning/Select** control and highlight "Yes" to proceed.

If you do not wish to carry out a system reset, highlight "No" and then press the control.

4. With "Yes" highlighted, press the **Tuning/Select** control. A full reset will be performed. The station list and presets will be erased. The alarm setting will be cancelled, display brightness and sleep timer settings will be set to their default values. The clock will be reset and the unit will behave as when first switched on (see page 6).

In case of malfunction due to electrostatic discharge, reset the product as described above to resume normal operation. If you are not able to perform the reset operation as above, removal and reconnection of the power supply and batteries may be required.

If a problem persists our technical staff would be pleased to offer any assistance on operating the radio. Our technical helpline number is 020 8758 0338.

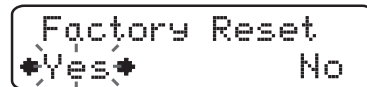
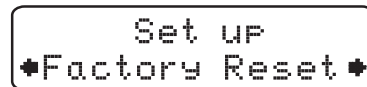
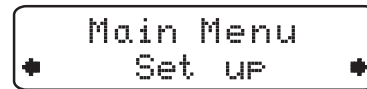
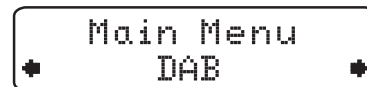
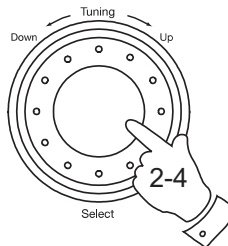
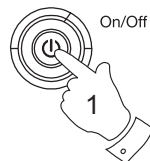

General

Do not allow this radio to be exposed to water, steam or sand. Do not leave your radio where excessive heat could cause damage such as in a parked car where the heat from the sun can build up even though the outside temperature may not seem too high. It is recommended that the DAB band be used wherever possible as better results in terms of quality and freedom from interference will usually be obtained than on the FM band.



- The radio should not be exposed to dripping or splashing and that no objects filled with liquids such as vases, shall be placed on the radio.
- It is recommended to operate the product such that there is a minimum distance (10cm recommended) to adjacent objects in order to ensure good ventilation.
- The ventilation of the product should not be restricted by covering it or its ventilation openings with items such as newspapers, table-cloths, curtains etc.
- No naked flame sources such as lighted candles should be placed on the product.
- It is recommended to avoid using or storing the product at extremes of temperature. Avoid leaving the unit in cars, on window sills in direct sunlight etc.
- The nameplate is located on the underside of your radio.

Specifications

Power Requirements

Mains AC 110 \sim 240V 50/60 Hz (switching adaptor)
Batteries 6 x LR20 (D size)

Battery Life

Up to 150 hours of listening for 4 hours a day at normal volume using alkaline cells.
(See page 5).

Frequency Coverage

FM 87.5-108MHz
DAB 174.928 - 239.200MHz

Circuit Features

Loudspeaker	2 x 79mm
Output Power	3W
Headphone socket	3.5mm dia. Stereo
Auxiliary input socket	3.5mm dia. Stereo
Aerial System	FM Telescopic aerial DAB Telescopic aerial

The Company reserves the right to amend the specification without notice.

Guarantee

This instrument is guaranteed for twelve months from the date of delivery to the original owner against failure due to faulty workmanship or component breakdown, subject to the procedure stated below. Should any component or part fail during this guarantee period it will be repaired or replaced free of charge.

The guarantee does not cover:

1. Damage resulting from incorrect use.
2. Consequential damage.
3. Receivers with removed or defaced serial numbers.

N.B. Damaged or broken telescopic aerials will not be replaced under guarantee.

Procedure:

Any claim under this guarantee should be made through the dealer from whom the instrument was purchased. It is likely that your Roberts' dealer will be able to attend to any defect quickly and efficiently, but should it be necessary the dealer will return the instrument to the company's service department for attention. In the event that it is not possible to return the instrument to the Roberts' dealer from whom it was purchased, please contact Roberts Radio Technical Services at the address shown on the rear of this manual.

These statements do not affect the statutory rights of a consumer.

ROBERTS RADIO TECHNICAL SERVICES

97-99 Worton Road

Isleworth Middlesex

TW7 6EG

Technical Helpline :- 020 8758 0338 (Mon-Fri during office hours)

Website: <http://www.robertsradio.co.uk>



Issue 1

© 2010 Roberts Radio Limited

