

ROBERTS

Enjoy Listening

expression

DAB / FM RDS Stereo Digital Radio with built-in battery charger



Digital Audio Broadcasting

Please read this manual before use

Contents

<i>Controls</i>	2-3	<i>Software version</i>	20
<i>Battery operation using alkaline batteries</i>	4	<i>System reset</i>	21
<i>Battery operation using rechargeable batteries</i>	5	<i>Headphone socket</i>	22
<i>Using the AC adaptor</i>	6	<i>Auxiliary input socket</i>	22
<i>Operating your radio - DAB</i>	7	<i>A few words about batteries</i>	23-24
<i>Selecting a station - DAB</i>	8	<i>Display backlight</i>	25
<i>Display modes - DAB</i>	9	<i>USB socket for software upgrades</i>	25
<i>Finding new stations - DAB</i>	10	<i>General</i>	26
<i>Secondary services - DAB</i>	10	<i>Specifications</i>	26
<i>Manual tuning - DAB</i>	11	<i>Circuit features</i>	26
<i>Signal strength display - DAB</i>	11	<i>Guarantee</i>	<i>Back page</i>
<i>Dynamic range control (DRC) settings - DAB</i>	12		
<i>Operating your radio - Search tuning - FM</i>	13		
<i>Manual tuning - FM</i>	14		
<i>Display modes - FM</i>	15		
<i>Favourite button</i>	16		
<i>Recalling your favourite station</i>	16		
<i>Preset stations DAB and FM</i>	17		
<i>Stereo / Mono setting - FM</i>	18		
<i>Scan sensitivity setting - FM</i>	19		

Controls

(Top)

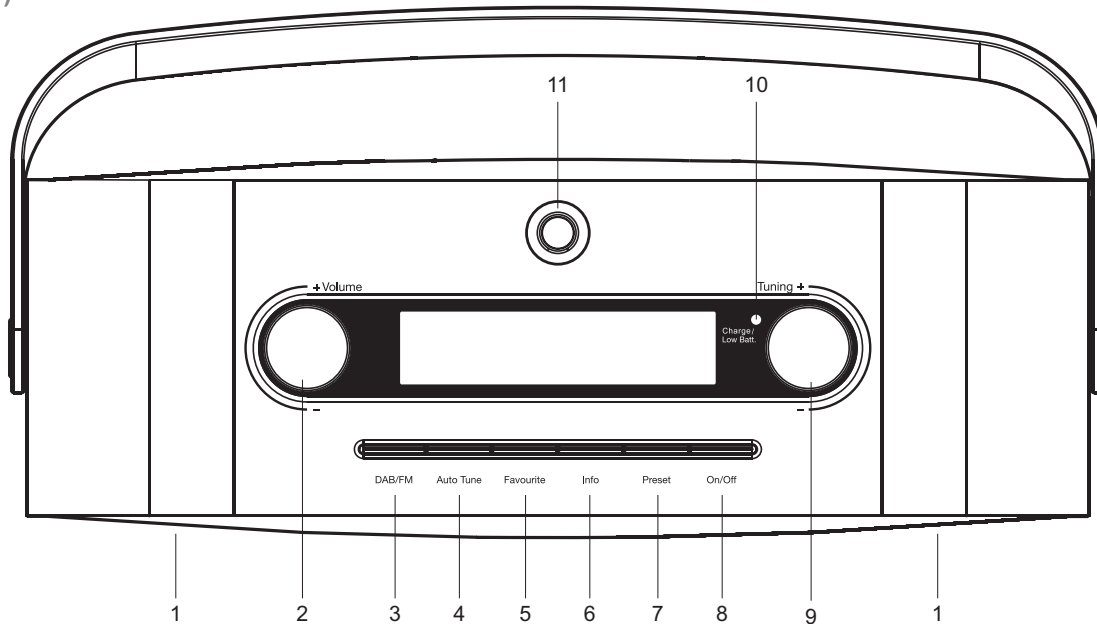

1. Speaker x 2

2. Volume control

3. DAB / FM button

4. Auto Tune button

5. Favourite button

6. Info button

7. Preset button

8. On / Off button

9. Tuning / Select control

10. Charge / Low battery indicator

11. Telescopic aerial

Controls

(Rear)

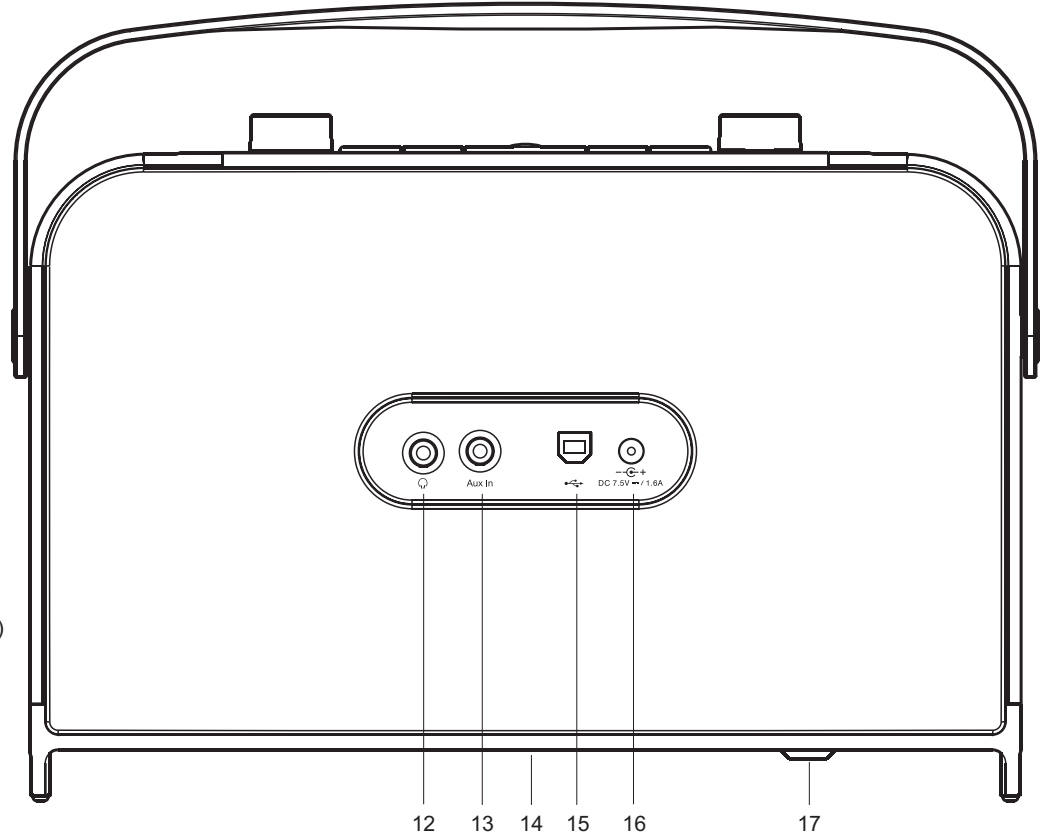

- 12. Headphone socket
- 13. Auxiliary input socket
- 14. Battery compartment
- 15. USB socket (for service use only)
- 16. DC input socket
- 17. Battery compartment screw

Battery operation using alkaline batteries (also see page 23)

1. Ensure your radio is disconnected from the mains supply and the aerial is fully retracted.
2. Open the **battery cover** on the base of the unit by using a flat bladed screwdriver to loosen the screw securing the battery cover.
3. Slide the switch inside the battery compartment to the **Alkaline** position.
4. Insert four LR20 (D size) Alkaline batteries into the spaces in the compartment. Take care to ensure all batteries are inserted with the correct polarity as shown inside the battery compartment.
5. Close the battery cover and gently tighten the screw using a flat bladed screwdriver. Do not overtighten.

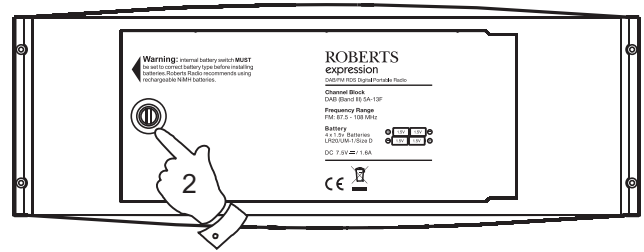

- **Important: when using Alkaline batteries the battery switch must be placed in the Alkaline position. Failure to do so could result in serious damage to the batteries or radio.**
- When the batteries are exhausted, the charge/low battery indicator will show red for a short while. The radio will then switch itself off. It may not be possible to switch the radio back on until the batteries are replaced, or until the radio is connected to the mains adaptor.
- If the radio is not to be used for any extended period of time it is recommended that the batteries are removed from the radio.
- *We would recommend for economy that the **Expression** is used via the AC adaptor whenever possible with battery operation for occasional use only. If extended listening using batteries is anticipated, then the use of rechargeable batteries is recommended.*

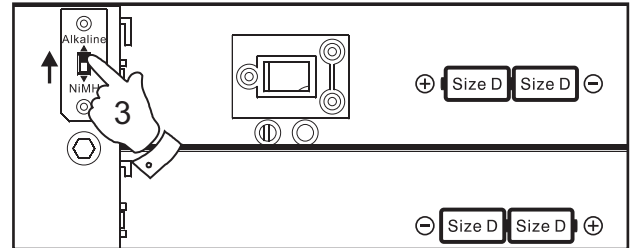

Battery operation using rechargeable batteries (also see page 23)

1. Ensure your radio is disconnected from the mains supply and the aerial is fully retracted.
 2. Open the **battery cover** on the base of the unit by using a flat bladed screwdriver to loosen the screw securing the battery cover.
 3. Slide the switch inside the battery compartment to the **NiMH** position.
 4. Insert four Rechargeable LR20 (D size) batteries into the spaces in the compartment. Take care to ensure all batteries are inserted with the correct polarity as shown inside the battery compartment. The radio is designed to be used with Nickel Metal Hydride (NiMH) rechargeable batteries.
 5. Close the battery cover and gently tighten the screw using a flat bladed screwdriver. Do not overtighten.
 6. Plug the mains adaptor into your radio and then plug the adaptor into the mains.
 7. The Charge light will flash green indicating that the batteries are charging. Batteries will be fully charged in around 3- 7 hours depending on their capacity. The charge light shows a steady green light when the battery charging is complete.
- **Important: when using rechargeable batteries the battery switch must be placed in the NiMH position. Batteries will only be charged when the radio is switched off and connected to the AC adaptor.**
 - When the batteries are exhausted, the charge/low battery indicator light will show red for a short while. The radio will then switch itself off. It may not be possible to switch the radio back on until the batteries are recharged, or until the radio is connected to the mains adaptor.
 - If the radio is not to be used for any extended period of time it is recommended that the batteries are removed from the radio.

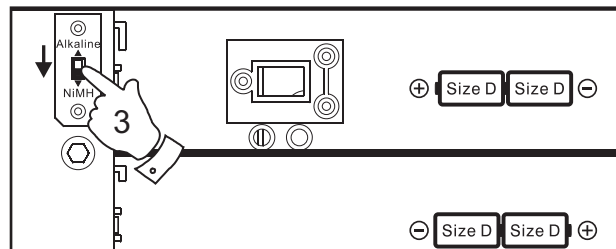
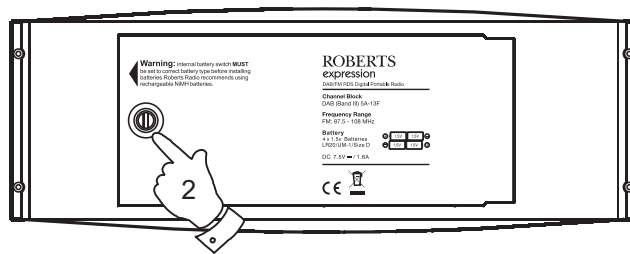

IMPORTANT: The batteries should not be exposed to excessive heat such as sunshine, fire or the like. After use, disposable batteries should if possible be taken to a suitable recycling centre. On no account should batteries be disposed of by incineration.

Using the AC adaptor

1. Insert the adaptor plug into the **DC in socket** on the rear of your radio.
2. Plug the adaptor into a standard 13A mains socket outlet. Whenever the adaptor is plugged in to the radio and switched on at the mains the batteries are automatically disconnected. If the adaptor is plugged in to the radio but not switched on then the radio will run from the batteries if fitted.

The AC adaptor should be disconnected from the mains supply and the radio when not in use.

- **IMPORTANT:** The mains adaptor is used as the means of connecting the radio to the mains supply. The mains socket used for the radio must remain accessible during normal use. In order to disconnect the radio from the mains completely, the mains adaptor should be removed from the mains socket outlet completely.

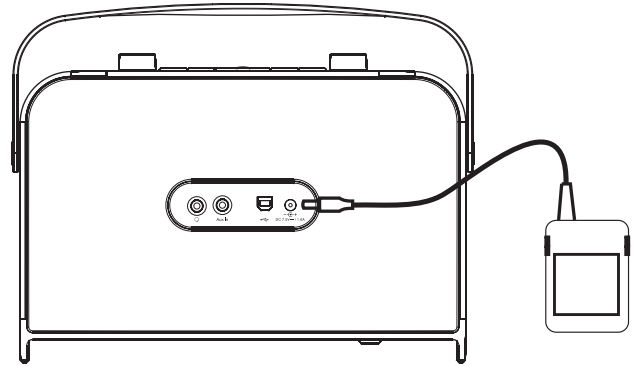

Operating your radio - DAB

1. Carefully extend the telescopic aerial.
2. Press the **On/Off** button to switch on your radio. The display will show "Welcome to DAB".
3. If this is the first time the radio is used a quick scan of the Band III DAB channels will be carried out. If the radio has been used before the last used station will be selected.
4. During the scanning process, the lower line of the display shows a bar-graph indicating progress of the scan.
5. When the scanning is completed the first station (in numeric-alpha order 0...9...A...Z) will be selected.
6. If the station list is still empty after the scan your radio will display "Service not available".
7. If no signals are found it may be necessary to relocate your radio to a position giving better reception. Then, either switch your radio off and on again, or press the **Auto Tune** button to repeat the scan.

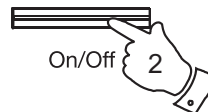

```
Welcome to DAB
■■■■■■■■■■
```

```
BBC R7      DAB
Now tuning...
```

```
BBC R7      DAB
Im sorry I have
```

```
Classic     DAB
Service not avai
```

Selecting a station - DAB

1. The top line of the display shows the name of the station currently selected.
2. Rotate the **Tuning** control to scroll through the list of available stations on the lower line of the display. Stop rotating the Tuning control when you find the station that you wish to hear.
3. Press and release the **Tuning** control to select the station. The display may show "Now tuning..." while your radio finds the new station.
4. Adjust the **Volume** control to the required setting.

Note: If after selecting a station the display shows "Service not available" it may be necessary to relocate your radio to a position giving better reception.

The use of radio station presets for selecting your preferred radio stations is described on page 17.

Classic DAB
Classical Music

Tuning +

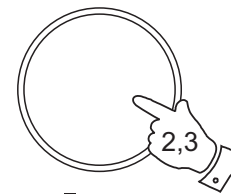

Classic DAB
+BBC 7 +

BBC R7 DAB
Now tuning...

+ Volume

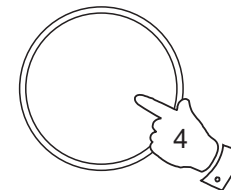

Display modes - DAB

Your radio has a range of display modes:-

1. Press the **Info** button to cycle through the various modes.

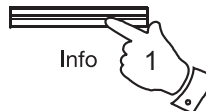

a. Scrolling text Displays scrolling text messages such as artist/track name, phone in number etc.

b. Program Type Displays the type of station being listened to e.g. Pop, Classic, News etc.

c. Multiplex Name Displays the name of DAB multiplex to which the current station belongs.

d. Time and date Displays the current time and date.

e. Frequency Displays the frequency of the DAB multiplex for the station listened to.

f. Bit rate & audio type Displays the digital bit rate & audio type for the station being listened to.

g. Signal Strength Displays a graph showing the signal strength for the station being received.

a BBC R7 DAB
 Im sorry I have

b BBC R7 DAB
 Varied Speech

c BBC R7 DAB
 BBC National DAB

d BBC R7 DAB
 19:17 08-06-2010

e BBC R7 DAB
 12B 225.64MHz

f BBC R7 DAB
 80kbps / MP2

g BBC 7 DAB
 ■■■■■ □ ■■■■■

Finding new radio stations - DAB

As time passes new stations may become available. To find new stations proceed as follows:-

1. Press and release the **Auto Tune** button. The display will show "Scanning..." and your radio will perform a scan of the Band III DAB channels. As new radio stations are found the station counter on the right-hand side of the display will increase and the radio stations will be added to the list stored in the radio.

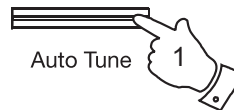

Secondary services - DAB

1. Certain radio stations have one or more secondary services associated with them. If a radio station has a secondary service associated with it the display will show ">>" next to the station name on the station list. The secondary service will then appear immediately after the primary service as you rotate the tuning control clockwise.
2. Press and release the **Tuning** control to select the station.
3. When the secondary service shuts down, your radio will automatically switch back to the main radio station (or primary service) if it is available.

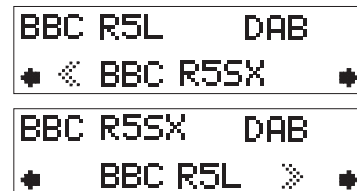
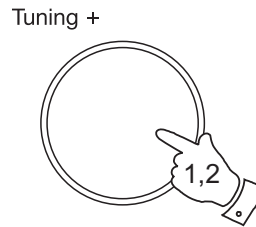

Manual Tuning - DAB

Manual tuning allows you to tune directly to the various DAB Band III channels. UK DAB stations are currently located in the range 11B to 12D.

1. Press and hold in the **Info** button until the display shows "Manual tune". Press and release the **Tuning** control to select this function.
2. Rotate the **Tuning** control to select the required DAB channel.
3. Press and release the **Tuning** control. The open block in the signal strength graph shows you the minimum signal strength needed for good DAB reception. The signal blocks will go up and down showing the changing signal strength as you adjust the telescopic aerial or the radio position. Any new radio stations found on the tuned DAB multiplex will be added to the list stored in the radio.
4. Press and release the **Tuning** control to return to the normal tuning mode.

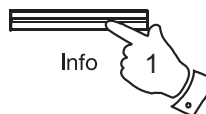

Tuning +

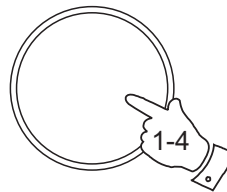

DAB
Manual tune

Manual tune
5A 174.928MHz

■■■■■
11D 222.064MHz

Classic DAB
Now tuning...

Signal strength display - DAB

1. Repeatedly press and release the **Info** button until the lower line of the display shows signal strength.
2. Position your radio and try adjusting the aerial so as to give maximum number of black rectangles on signal strength display. Normally, the best reception will be found with the aerial fully extended.
3. The clear unfilled rectangle indicates minimum signal level required for satisfactory reception.

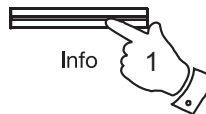

BBC R7 DAB
■■■■■

Dynamic Range Control settings - DAB

Dynamic Range Control (also known as DRC) can make quieter sounds easier to hear when your radio is used in a noisy environment.

1. Press the **On/Off** button to switch on your radio.
2. Press and hold in the **Info** button. The display will show "Manual tune."
3. Rotate the **Tuning** control until the display shows "DRC".
4. Press and release the **Tuning** control to enter the adjustment mode.
5. Rotate the **Tuning** control to select the required DRC setting (the default is 0).
 - DRC 0 - DRC is switched off, Broadcast DRC will be ignored.
 - DRC 1/2 - DRC level is set to 1/2 that sent by broadcaster.
 - DRC 1 - DRC level is used as sent by broadcaster.
6. Press and release the **Tuning** control to confirm the setting. The display will return to normal tuning mode.

Note: Not all DAB broadcasts are able to use the DRC function. If the broadcast does not support DRC, then the DRC setting in the radio will have no effect.

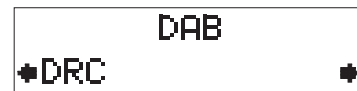
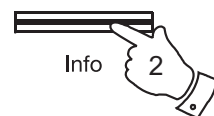
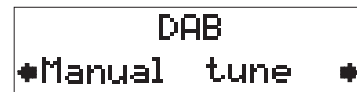
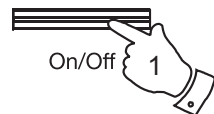

Tuning +

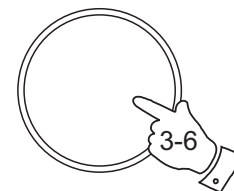

Operating your radio - Search tuning - FM

1. Carefully extend the telescopic aerial fully.
2. Press the **On/Off** button to switch on your radio.
3. Press the **DAB/FM** button to select the FM band.
4. Press and immediately release the **Auto tune** button, your radio will scan in an upwards direction (low frequency to high frequency) and stop automatically when it finds a station of sufficient strength.
5. After a few seconds the display will update. The display will show the frequency of the signal found. If the signal is strong enough and there is RDS data present then the radio will display the station name.
6. To find other stations, press and release the **Auto tune** button as before.
7. To scan the FM band in a downwards direction (high frequency to low frequency) press and hold down the **Auto tune** button for 2 seconds and then release.
8. When the waveband end is reached your radio will recommence tuning from the opposite waveband end.
9. Adjust the **Volume** control to the required setting.

The use of radio station presets for selecting your preferred radio stations is described on page 17.

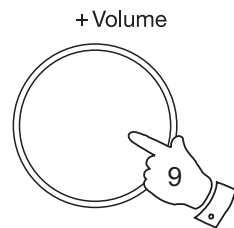
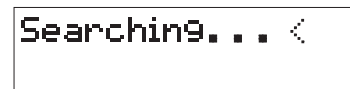
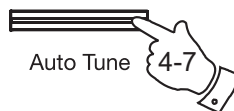
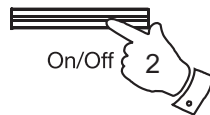

If you find that an FM broadcast has a lot of background hiss, this may often be reduced by setting the radio into Mono reception mode for the current FM station. Please refer to the section "Stereo / Mono setting - FM" on page 18 for further details.

Manual tuning - FM

1. Press the **On/Off** button to switch on your radio.
2. Press the **DAB/FM** button to select the FM band. Carefully extend the telescopic aerial fully for FM reception.
3. Rotate the **Tuning** control to tune to a station. With each click of the control the frequency will change up or down by 50 kHz.
4. When the waveband end is reached the radio will recommence tuning from the opposite waveband end.
5. Set the **Volume** control to the desired settings.
6. To switch off your radio press the **On/Off** button.

If you find that an FM broadcast has a lot of background hiss, this may often be reduced by setting the radio into Mono reception mode for the current FM station. Please refer to the section "Stereo / Mono setting - FM" on page 18 for further details.

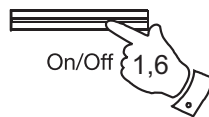

Tuning +

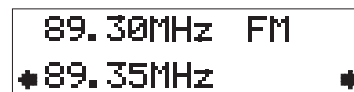
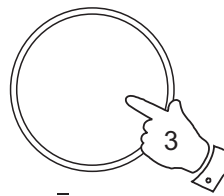

+ Volume

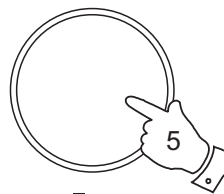

Display modes - FM

The Radio Data System (RDS) is a system in which inaudible digital information is transmitted in addition to the normal FM radio programme. RDS offers several useful features. In FM mode the bottom line of the display can be set to any of the following display options:-

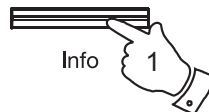

1. Press the **Info** button to cycle through each of the options.
 - a. Scrolling text Displays scrolling text messages such as artist/track name, phone in number etc.
 - b. Program type Displays type of station being listened to e.g. Pop, Classic, News, etc.
 - c. Time and date Displays the current time and date.
 - d. Frequency Displays frequency of the station being listened to.
 - e. Audio mode Display shows Auto (stereo) or Mono.

Note: Your radio will display "No Radio Text" on the lower line of the display if there is no scrolling text available and "No PTY" if there is no programme type information.

a

BBC R2	FM
The latest news	

b

BBC R2	FM
Pop Music	

c

BBC R2	FM
12:02 16-06-2010	

d

BBC R2	FM
89.30MHz	

e

89.30MHz	FM
Auto (Stereo)	

Favourite button

Your radio is fitted with a button which when pressed will automatically select the required waveband and tune to your Favourite radio station. With this button you can store one favourite station from either the DAB or FM wavebands.

To set up your favourite station, follow these steps:

1. Carefully extend the telescopic aerial and switch on your radio.
2. Select the desired waveband (DAB or FM) and tune into the required radio station as described on the preceding pages.
3. Press and hold down the **Favourite** button (for 5 seconds) until the display shows "My Fav. Saved".

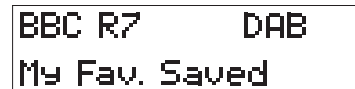

Recalling your favourite station

1. Carefully extend the telescopic aerial and switch on your radio.

If your radio is in Auxiliary Input mode, press and release the **DAB/FM** button to select normal radio operation.

2. Momentarily press the **Favourite** button, your radio will automatically select the DAB or FM waveband as needed and then tune to the radio station stored in the favourite memory.

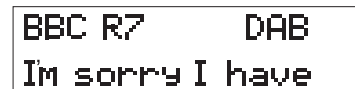

Preset stations - DAB and FM

To make it easier for you to tune your radio to the stations that you prefer, you may store selected radio stations as presets. Your radio holds presets separately for DAB and FM radio modes.

You may set as many or as few presets as you like in each mode.

You can easily switch between displaying all DAB stations (or all FM frequencies) and displaying only those that you have set as presets.

Any station or frequency which has been marked as a preset can easily have the mark cancelled should your preferences or needs change.

Presets are retained when your radio is switched off.

1. To setup your preset stations, tune into the required station.
2. Press and hold down the **Preset** button until the displays shows a tick symbol next to the radio station name or frequency. This indicates that the radio station is marked as a preset. To cancel the preset mark, press and hold the **Preset** button again.
3. Repeat steps 1 and 2 as needed for any other stations that you want as presets.
4. To view only the preset stations for the currently selected waveband when tuning, press and release the **Preset** button so that the heart symbol shows in the display.
5. To listen to one of the preset radio stations, rotate the **Tuning** control until the required radio station is displayed. Press and release the **Tuning** control to select and tune to that station.
6. To cancel the preset stations view, press and release the **Preset** button so that the heart symbol disappears from the display. Your radio will then be able to access the full station list using the **Tuning** control.

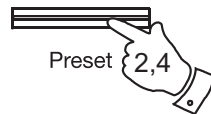

Classic ✓ DAB
Classical Music

Tuning +

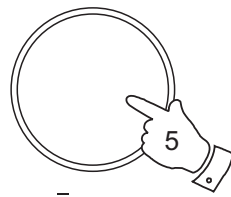

Classic ✓ DAB ♥
Classical Music

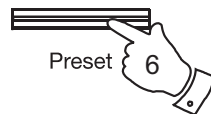

Stereo / Mono setting - FM

Your radio will play stereo FM broadcasts in stereo provided that the received signal is of adequate strength. However, as a stereo signal becomes weaker the audio signal will become poorer. It may be preferable to force the radio to play the station in mono in order to reduce the level of background hiss.

1. Press the **On/Off** button to switch on your radio.
2. Tune to the required FM radio station as previously described (see pages 13, 14).
3. Press and release the **Tuning** control so that the display shows "Switch to Mono". The radio will play the current station in mono.

The Mono override is a temporary setting and is applied to the currently tuned station only. It is cancelled automatically by tuning to another station.

4. If you wish to cancel the Mono override while listening to the currently tuned radio station, press and release the **Tuning** so that the display shows "Switch to Auto". The radio will play the current station in stereo if the signal is sufficiently strong.

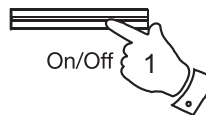

89.30MHz FM
Switch to Mono

Tuning +

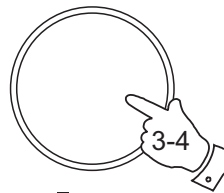

89.30MHz FM
Switch to Auto

Scan sensitivity setting - FM

Your radio will normally scan for FM broadcasts which are strong enough to give good reception. However, you may wish the Auto-scan function to also be able to find weaker signals, possibly from more distant radio transmitters. Your radio includes a local / distant option for the Auto-scan function.

1. Press the **On/Off** button to switch on your radio.
2. If needed, press the **DAB/FM** button to select the FM band.
3. Press and hold the **Info** button until the display shows "FM Scan Zone" then press the **Tuning** control to enter the scan zone selection menu.
4. Rotate the **Tuning** control to switch between Local and Distant options on the lower line of the display. The Distant option will allow the radio to find weaker signals when scanning.
The currently stored setting will be shown with an asterisk on the display.
5. Press and release the **Tuning** control to confirm your selection. The radio will then revert to the normal information display. The Local or Distant setting is stored in the radio and remains in force until changed or until a System Reset.

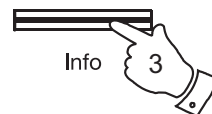
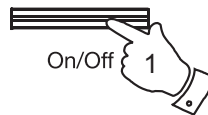

Tuning +

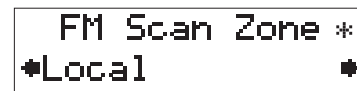
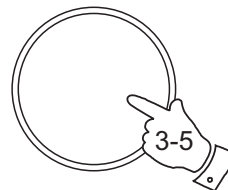

Note: The initial setting (out of the box, or after a System Reset) causes the radio to ignore weaker (or more distant) signals.

Software version

The software display cannot be altered and is just for your reference.

1. To view the software version on the display, ensure your radio is in DAB mode and press and hold the **Info** button for 2 seconds.
2. Rotate the **Tuning** control until the display shows “SW version”. Press the **Tuning** control the software version will appear on the display.
3. Press the **Info** button to revert to the normal display mode.

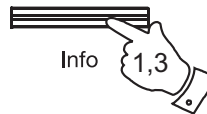

Tuning +

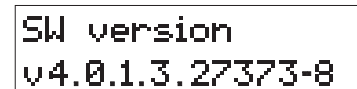
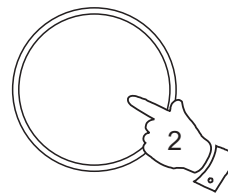

System reset

If your radio fails to operate correctly, or some digits on the display are missing or incomplete, it may be possible to restore normal operation by carrying out a System Reset operation on your radio. This will restore the radio's settings to their factory defaults. No presets will be stored, and the list of DAB radio stations will be empty.

If you have moved to a different part of the country and you wish to erase local DAB radio stations that are no longer available from the stored list, then you may carry out this procedure. Your radio will automatically re-scan for the DAB stations available at your current location when it restarts.

1. Ensure your radio is in DAB or FM mode. Press and hold down the **Info** button for 2 seconds.
2. Rotate the **Tuning** control until the display shows "Factory Reset", then press and release the **Tuning** control.
3. If you wish to perform the reset operation, press and release the **Tuning** control **one more time**. A full reset of your radio will be performed. All presets and station lists will be erased.
4. After a system reset a scan of the DAB band will be performed.

In case of malfunction due to electrostatic discharge, reset the product (temporary disconnection of the power adaptor and removal of batteries may be required) to resume normal operation.

If a problem persists our technical staff would be pleased to offer any assistance on operating the radio. Our technical helpline number is 020 8758 0338.

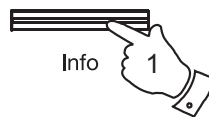

Tuning +

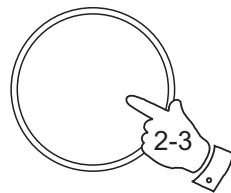

DAB
Factory Reset

Press SELECT to
confirm reset...

Welcome to DAB
■■■■■■■■■■

Headphone socket

A 3.5mm **Headphone Socket** located on the rear of your radio is provided for use with either headphones or an earpiece. Inserting a plug automatically mutes the internal loudspeaker.

Please be aware that sensitivity of headphones can vary widely. We therefore recommend setting volume to a low level before connecting headphones in the radio.

IMPORTANT: Excessive sound pressure from earphones and headphones can cause hearing loss.

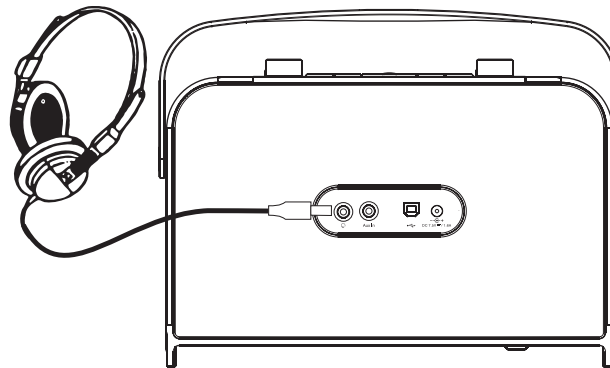

Auxiliary input socket

1. Connect a stereo or mono audio source (i.e. CD player, MP3 player, etc.) to the **Auxiliary input socket**.
2. Press the **On/Off** button to switch on the radio. Press and release the **DAB/FM** button until the display shows "AUX IN".

Note that the Auxiliary Input mode can only be selected when a plug is inserted in the socket.

3. Adjust the **Volume control** on your player and on the radio for comfortable listening.
4. Remove the cable from the **Auxiliary input socket** or press and release the **DAB/FM** button to cancel Auxiliary Input mode.

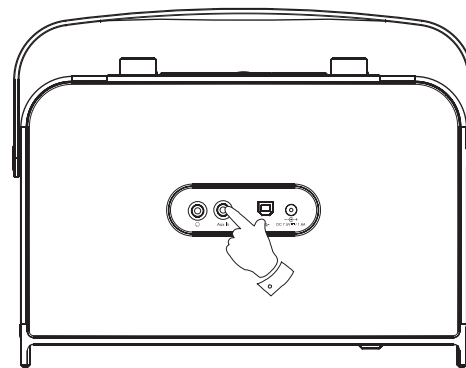

A Few Words about Batteries...

Your Roberts **Expression** radio has been designed to use a choice of power sources. You may plug it into the mains using the supplied high-efficiency adaptor, or for listening away from the mains you may use either alkaline or rechargeable batteries. We do not recommend the use of carbon-zinc or zinc-chloride batteries.

It is very important that you read the advice and warnings given below.

- 1) Whichever type of batteries you choose to use, it is very important that the battery selection switch under the cover is set to the correct type.
 - a. If no batteries are fitted, then set the switch to the Alkaline position. This position minimises the power consumption when the radio is powered from the mains.
 - b. If Alkaline batteries are fitted, then set the switch to the Alkaline position.
 - c. If Rechargeable batteries are fitted, then set the switch to the NiMH position. Your radio is designed to use Nickel-Metal-Hydride rechargeable batteries. No other type of rechargeable battery should be used in the radio.
- 2) **NEVER** mix old and new Alkaline batteries. The old batteries may suffer damage and leak which will damage your radio and whatever the radio is standing on.
- 3) **NEVER** mix old and new Rechargeable batteries. This may result in unreliable charging and shortened battery life. Never mix Rechargeable batteries of different types or capacities even if they are new.
- 4) **NEVER** mix Alkaline and Rechargeable batteries. The recharging of Alkaline batteries can be very dangerous.

Rechargeable batteries

Your **Expression** radio uses a range of methods to ensure correct and safe charging of Rechargeable Nickel-Metal-Hydride batteries. These work to protect your batteries from excessive charge and discharge. These protections can only work properly if the advice above is followed. In particular, the radio will not be able to correctly charge batteries if they are a mixture of different brands, or different ages, or different capacities.

We recommend that all the rechargeable batteries used in your radio are bought together as a set. They should always be charged together and discharged together and not "borrowed" from time to time for other applications. This will ensure that they give their optimum performance in your radio.

We recommend that the rechargeable batteries that you use should be from a quality brand, and should be of at least 2500mAh capacity. Batteries of this capacity should power your radio for between 10 and 15 hours depending upon the volume of the radio, whether DAB or FM mode is used (DAB mode uses slightly less power than FM), and also depending on the condition of the batteries. Higher capacity batteries are available and will give longer life, but will generally be more expensive.

Before you first install a new set of rechargeable batteries into your radio you should first make sure that the battery type switch beneath the battery cover is in the NiMH position. Install the batteries arranging them as shown inside the battery compartment. Plug the mains adaptor into the radio and then into the mains socket. While the batteries are charging the charge indicator should show a flashing green light. When the batteries are fully charged the indicator will stop flashing and will show a steady green light. The time taken to charge the batteries will depend on how much charging they require. New batteries may be partly charged when first fitted, but it is normal for a set of batteries to take several hours to charge fully (this can be between 3 and 7 hours depending on the battery capacity and their initial state of charge).

If you use the radio powered from the batteries, the charge/low battery indicator light will be off until the batteries are exhausted. The charge/low battery indicator light will then show red for a short while before the radio switches itself off. It does this in order that the batteries are not excessively discharged. This would otherwise damage the batteries and shorten their life.

If you use the radio powered from the mains with rechargeable batteries fitted, the charging process is suspended until you switch off the radio. When you switch off the radio using its On/Off button charging will then resume. If the batteries have already been charged then they will only charge for a few more minutes before the charge indicator stops flashing.

If you only listen to your radio for short periods, you do not need to connect your radio to the mains to charge the batteries every time that you use it. However, if the radio is not to be used for a few weeks, then we recommend that the batteries are fully charged (charge light shows steady green) before the radio is put to one side.

If you intend not to use your radio for some months, then we recommend that the batteries are removed and put away, keeping them in a cool place out of reach of children, away from moisture and such that no metal object can contact the battery terminals.

With care, rechargeable batteries can last a long time and can operate for many hundreds of charge and discharge cycles. When your rechargeable batteries can no longer power your radio adequately, please dispose of them responsibly using a local battery recycling facility.

To avoid danger and risk of injury, please follow these guide lines

Improper use of batteries may result in leakage of fluid, overheating or explosion. Battery fluid is corrosive and may also be toxic. Battery fluid can cause skin burns, can damage the eyes, and can be harmful if swallowed.

1. Keep batteries out of the reach of children.
2. Do not heat, open, puncture, mutilate or dispose of batteries by burning.
3. Do not mix different battery types or old and new batteries. Always replace all the batteries at the same time.
4. Do not carry or store batteries such that metal objects may contact the end caps.
5. Remove batteries from the radio if they are worn out or if you are storing it for a long time.
6. Remove old or worn out batteries promptly, and recycle or dispose of them according to the regulations applicable to your location.
7. If a battery does leak, remove all batteries from the product, taking care to avoid directly touching the leaked fluid. If the fluid contacts skin or clothes wash with water immediately. Before inserting new batteries, thoroughly clean the battery compartment with a damp paper towel, or follow the battery manufacturer's advice for clean up.

Display backlight

1. When using the radio powered from batteries, the display backlight will be switched on for approximately 12 seconds when any button is pressed.
2. When your radio is powered by the AC mains using the supplied mains adaptor the display backlight will always be on whenever the radio is switched on.

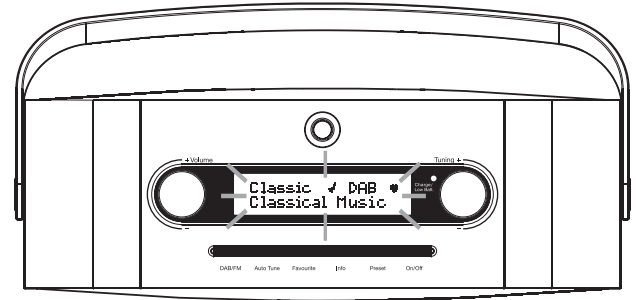

USB socket for software upgrade

A USB socket is provided at the rear of your radio for service use only to permit the possibility of updates to the internal software in the future.

If you register your product at www.robertsradio.co.uk/register and include a valid e-mail address you will receive notification of software updates.

General

Do not allow this radio to be exposed to water, steam or sand. Do not leave your radio where excessive heat could cause damage such as in a parked car where the heat from the sun can build up even though the outside temperature may not seem too high. It is recommended that the DAB band be used wherever possible as better results in terms of quality and freedom from interference will usually be obtained than on the FM band.

The name plate is located on the underside of your radio.



- Your radio should not be exposed to dripping or splashing and that no objects filled with liquids, such as vases, shall be placed on the radio.
- It is recommended to operate the product such that there is a minimum distance (10cm recommended) to adjacent objects in order to ensure good ventilation.
- The ventilation of the product should not be restricted by covering it or its ventilation openings with items such as newspapers, tablecloths, curtains etc.
- No naked flame sources such as lighted candles should be placed on the product.
- It is recommended to avoid using or storing the product at extremes of temperature. Avoid leaving the unit in cars, on window sills, in direct sunlight etc.

Specifications

Power Requirements

Mains AC 100 ~ 240V 50/60Hz (adaptor)

Batteries 4 x LR20 (D size)

Battery Life

Up to 100 hours of listening for 4 hours a day at normal volume using alkaline cells.

Up to 15 hours - 2500 mAh NiMH

Up to 40 hours - 9000 mAh NiMH

Frequency Coverage

FM 87.5-108MHz

DAB 174.928 - 239.200MHz

Circuit Features

Loudspeaker 2 x 76mm

Output Power 2 x 1 watt

Headphone socket 3.5mm dia. stereo

Auxiliary Input socket 3.5mm dia. stereo

Aerial System FM Telescopic aerial

DAB Telescopic aerial

The Company reserves the right to amend the specification without notice.

Guarantee

This instrument is guaranteed for twelve months from the date of delivery to the original owner against failure due to faulty workmanship or component breakdown, subject to the procedure stated below. Should any component or part fail during this guarantee period it will be repaired or replaced free of charge.

The guarantee does not cover:

1. Damage resulting from incorrect use.
2. Consequential damage.
3. Receivers with removed or defaced serial numbers.

N.B. Damaged or broken telescopic aerials will not be replaced under guarantee.

Procedure:

Any claim under this guarantee should be made through the dealer from whom the instrument was purchased. It is likely that your Roberts' dealer will be able to attend to any defect quickly and efficiently, but should it be necessary the dealer will return the instrument to the company's service department for attention. In the event that it is not possible to return the instrument to the Roberts' dealer from whom it was purchased, please contact Roberts Radio Technical Services at the address shown on the rear of this manual.

These statements do not affect the statutory rights of a consumer.

ROBERTS RADIO TECHNICAL SERVICES

97-99 Worton Road

Isleworth Middlesex

TW7 6EG

Technical Helpline :- 020 8758 0338 (*Mon-Fri during office hours*)

Website: <http://www.robertsradio.co.uk>



© 2010 Roberts Radio Limited