

ROBERTS

Sound for Generations

RD-41

DAB / FM RDS / MP3 / WMA / EPG digital radio

with timed recording and *PAUSEplus*



DAB

Digital Audio Broadcasting

Please read this manual before use

Contents

<i>Controls</i>	2-3	<i>Clock settings</i>	40
<i>Digital radio features</i>	4	<i>Setting the clock automatically</i>	40
<i>Battery operation</i>	5	<i>Setting the clock manually</i>	41-42
<i>Using the AC adaptor</i>	6	<i>Alarms</i>	43-51
<i>Using your radio for the first time - DAB</i>	7	<i>Cancelling alarms</i>	51
<i>Operation modes</i>	8	<i>Snooze function</i>	51
<i>Operating your radio - DAB</i>	8	<i>Sleep timer</i>	52
<i>Selecting a station - DAB</i>	9	<i>Clear station list</i>	53
<i>Finding new stations - DAB</i>	10	<i>Audio mode - FM</i>	54
<i>Manual tuning - DAB</i>	11	<i>Display settings backlight</i>	55
<i>Secondary services - DAB</i>	12	<i>Display settings contrast</i>	56
<i>Display modes - DAB</i>	12	<i>Factory reset</i>	57
<i>Using your radios Pause Plus feature - DAB</i>	13-14	<i>Connecting to an external amplifier or recorder</i>	58
<i>Using an SD memory card with your radio</i>	15	<i>Headphone socket</i>	58
<i>Recording a radio programme - DAB</i>	16	<i>Auxiliary input</i>	59
<i>Timed recording - DAB</i>	17-27	<i>Lock switch</i>	60
<i>SD card format</i>	28-29	<i>Standby display</i>	60
<i>Dynamic Range Control (DRC) settings - DAB</i>	30	<i>USB connection</i>	61
<i>File playback - DAB</i>	31-34	<i>General</i>	62
<i>Using the (Electronic programme guide) EPG - DAB</i>	35-36	<i>Specifications</i>	62
<i>Operating your radio FM - auto search</i>	37	<i>Circuit features</i>	62
<i>Operating your radio FM - manual tune</i>	38	<i>Guarantee</i>	Back page
<i>Presetting stations DAB and FM</i>	39		
<i>Recalling a preset station</i>	39		

Controls (top and front)

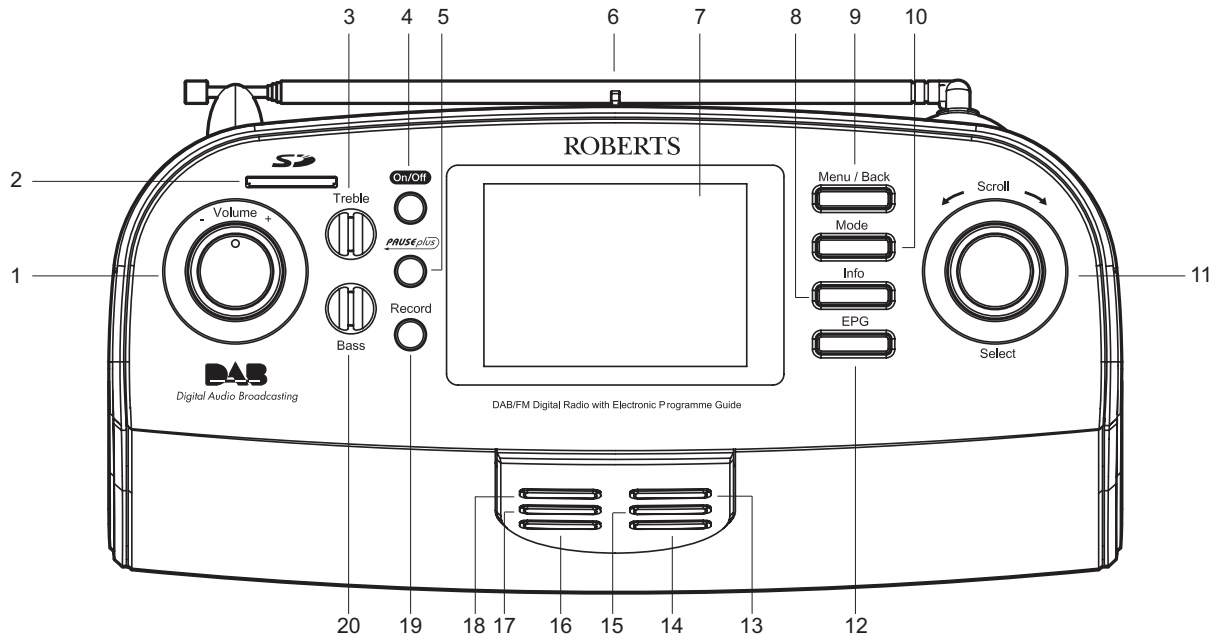

1. Volume control
2. SD card slot
3. Treble control
4. On/Off/Power button
5. **PAUSE PLUS** button
6. Telescopic aerial
7. LCD display

8. Info button
9. Menu/Back button
10. Mode button
11. Tuning/Select control
12. EPG button
13. Preset 2/Stop button
14. Preset 6/Delete button

15. Preset 4/Fastforward button
16. Preset 5/Repeat mode button
17. Preset 3/Rewind button
18. Preset 1/PlayPause button
19. Record button
20. Bass control

If you need any further advice, please call our Technical Helpline on :-
020 8758 0338 (Mon-Fri)

Controls (back)

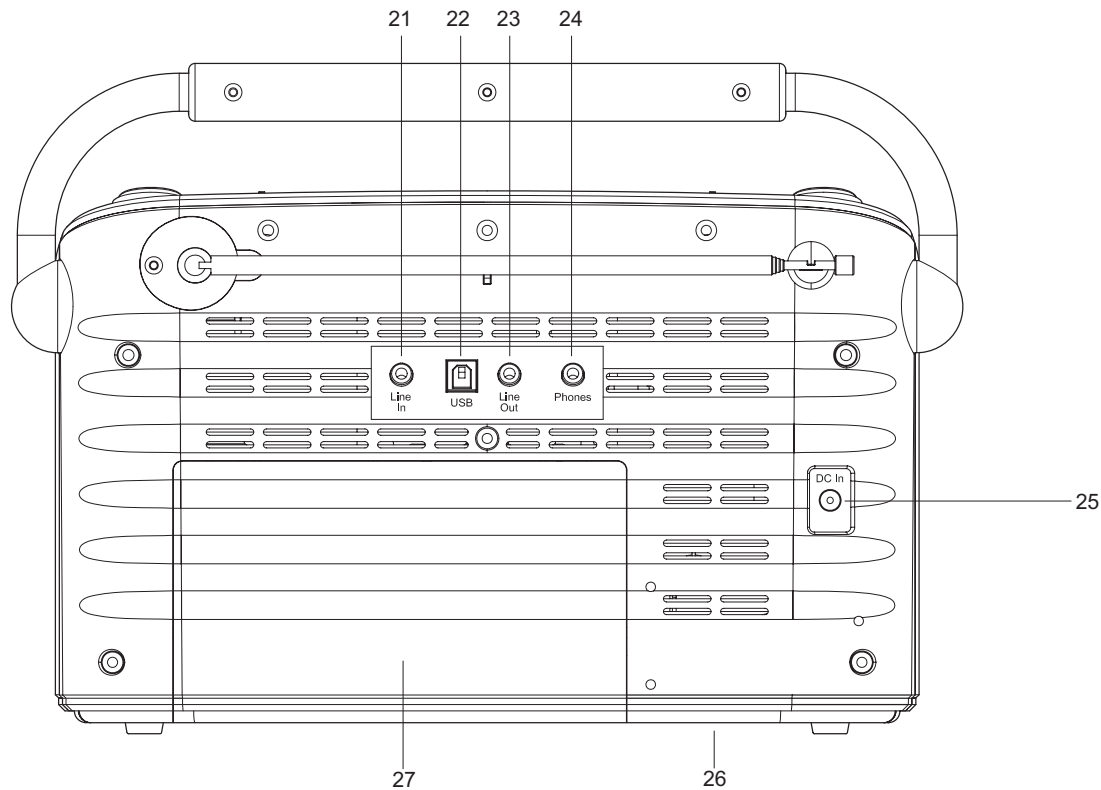

- 21. Auxiliary input socket
- 22. USB connector
- 23. Line out socket
- 24. Headphone socket

- 25. DC input socket
- 26. Keylock switch
- 27. Battery compartment

RD-41 Digital radio features

The Roberts RD-41 radio provides the following features in an attractive compact unit.

Radio

The RD-41 can receive DAB and FM (with RDS) wavebands.

Electronic programme guide (EPG)

The electronic programme guide provides start/stop times and program information similar to that provided for digital TV broadcasts. The EPG typically provides programme information for up to seven days.

SD card

An SD card can be used in your radio for recording, playing back previously recorded radio programs or playing back MP2, MP3 and WMA files transferred from a PC.

Record timers

The RD-41 has twelve timers which can be used to record from DAB radio to SD card. Timers may be set using the Electronic Program Guide (EPG), or to specified times. The timers allow repeated recordings to be made of broadcast series (daily, weekly, weekdays or weekends).

Alarms

The RD-41 has twelve alarms which can be set to wake you to either a radio station, playlist (SD card files) or a buzzer.

High resolution display

A large display panel provides an easy-to-read clock display when the radio is in standby mode. When the radio is in use, the large display makes it easier to choose which radio station to listen to and allows text messages which are broadcast to be read without scrolling.

Auxiliary input

The RD-41 can be used as an amplifier and loudspeaker system for external MP3 players, compact disc players and similar devices.

Headphone output

A standard 3.5mm headphone socket is provided for private listening.

Line output socket

A standard 3.5mm Line output socket is provided for connecting the audio signal from the radio to an external amplifier or recorder.

USB socket

Your radio has a USB connection to connect your PC. The USB port can be used to copy files to and from your SD card.

Battery operation

1. Remove the **Battery cover** on the rear of the unit by pushing battery door in and downwards.
2. Insert six LR20 (D size) batteries into the spaces in the compartment. Take care to ensure all batteries are inserted with the correct polarity as shown inside the battery compartment. Replace the battery cover.
3. Reduced power, a low battery indicator , distortion or a 'stuttering' sound are all signs that the batteries may need replacing.
4. If the radio is not to be used for any extended period of time it is recommended that the batteries are removed from the radio.

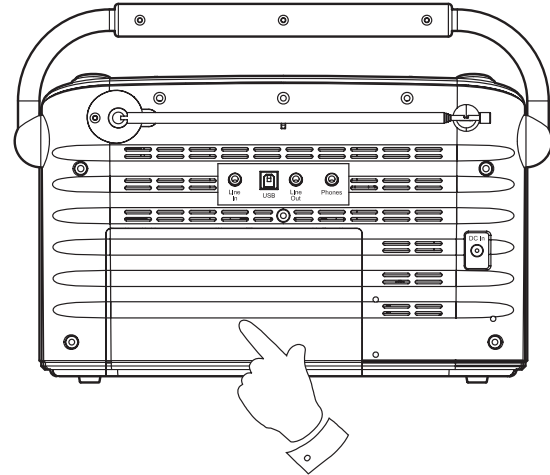

IMPORTANT: The batteries should not be exposed to excessive heat such as sunshine, fire or the like. After use, disposable batteries should if possible be taken to a suitable recycling centre. On no account should batteries be disposed of by incineration.

Using the AC adaptor

1. Place your radio on a flat surface and insert the adaptor plug into the DC socket located on the left side of your radio. The adaptor for use with your RD-41 should provide 9 volts DC output at 1.2 amps, centre pin positive.
2. Plug the adaptor into a standard 13 amp mains socket outlet. Whenever the adaptor is used the batteries are automatically disconnected.

We would recommend for economy that your radio is used via the AC adaptor whenever possible with battery operation for occasional use only.

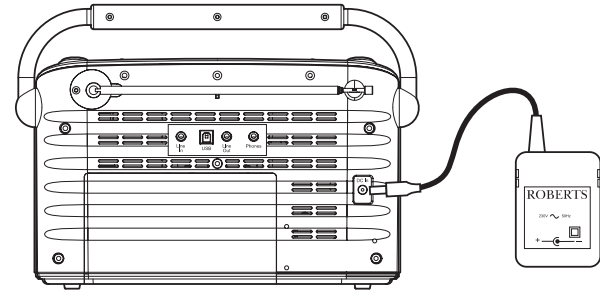

IMPORTANT: The mains adaptor is used as the means of connecting the radio to the mains supply. The mains socket used for the radio must remain accessible during normal use. In order to disconnect the radio from the mains completely, the mains adaptor should be removed from the mains socket outlet completely.

Using your radio for the first time - DAB

Your radio is supplied with a mains adaptor

1. Place your radio on a flat surface. Insert the adaptor plug into the DC socket located on the rear of your radio.
2. Fully extend the telescopic aerial. The aerial should be fully extended and positioned for optimum reception.
3. Plug the adaptor into a standard 13 amp mains socket outlet.
4. When your radio is first switched on the display will show "Roberts" and a quick scan of UK band III DAB and FM channels will be carried out. Note that if the radio has been used before the last used mode will be selected.
5. During Auto Tune as each group of stations is detected the display will show the number of stations found and a bargraph indicating progress of the Autotune.
6. When the Auto Tune is complete the first station (in numeric-alpha order 0...9...A...Z) will be selected.
7. If the station list is still empty after the DAB Auto Tune your radio will display "No Signal".
8. If no signals are found it may be necessary to relocate your radio to a position giving better reception.



Operation modes

Your radio has 3 operation modes, DAB, FM and Playlist mode.

1. Press the **Mode button** to change the operation mode between DAB, FM and Playlist.
 - DAB mode is used for listening to Digital Radio broadcasts and for recording programmes to a memory card.
 - FM mode is used for listening to FM radio broadcasts.
 - Playlist mode is used to play back digitally recorded programmes and for listening to MP3 and WMA audio files.

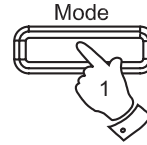

Operating your radio - DAB

1. Fully extend the telescopic aerial. The aerial should be fully extended and positioned for optimum reception.
2. Press the **Power/Standby button** to switch on your radio. If the radio has been used before, the last used mode will be selected.
3. If necessary, press the **Mode button** until DAB mode is selected.
4. The radio will then tune to the DAB station most recently listened to. The display will show the station name in the first line of the display and other information in the second line.
5. If no signals are found "No Signal" will be displayed and it may be necessary to relocate your radio to a position giving better reception. You should then carry out an autoscans to find stations as described on page 9.



Selecting a station - DAB

1. Fully extend the telescopic aerial.
 2. Press the **Power/Standby button** to switch on your radio.
 3. Rotate the **Tuning/Select control** until the station list appears.
 4. Continue to rotate the **Tuning/Select control** until the required station is highlighted on the display.
 5. Press and release the **Tuning/Select control** to select the station. The required station will be selected and after a few seconds the station name will appear on the display.
 6. Adjust the **Volume, Bass and Treble controls** to the required settings.
- Note: To return to the normal display mode from the station list without selecting a station press and release the **Menu/Back button** or simply wait a few seconds.

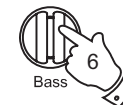
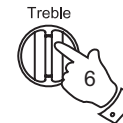
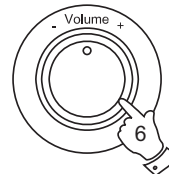
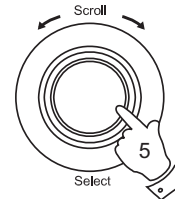
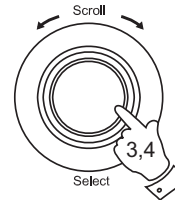

Finding new stations - DAB

As time passes new stations may become available. To find new stations proceed as follows:-

1. Press the **Mode button** until the DAB mode is selected.
2. Press the **Menu/Back button** to enter the main DAB menu.
3. Rotate the **Tuning/Select control** until "Stations" is highlighted on the display. Press and release the **Tuning/Select control** and the stations menu will appear on the display.
4. Rotate the **Tuning/Select control** until "Autoscan" is highlighted on the display. Press and release the **Tuning/Select control**.
5. Rotate the **Tuning/Select control** until "Band III" is highlighted on the display. Press and release the **Tuning/Select control**.
6. Your radio will carry out a scan of the entire band III UK frequencies. "Station Scan" will appear on the display. A progress bar will be shown on the display indicating autotune progress and number of stations found.
7. The scan can be cancelled at any time by pressing the **Menu/Back button**.

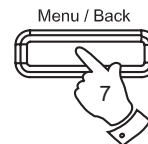
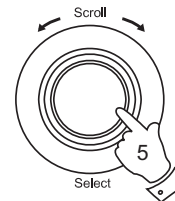
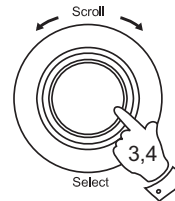
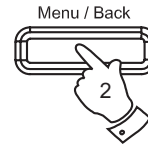
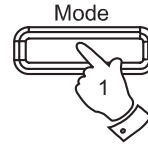

Manual Tuning - DAB

Manual tuning allows you to tune directly to the various DAB Band III channels. UK DAB stations are currently located in the range 11B to 12D.

1. Press the **Mode button** until the DAB mode is selected.
2. Press the **Menu/Back button** to enter the main DAB menu.
3. Rotate the **Tuning/Select control** until "Stations" is highlighted on the display. Press and release the **Tuning/Select control** the stations menu will appear on the display.
4. Rotate the **Tuning/Select control** until "Manual tune" is highlighted on the display. Press and release the **Tuning/Select control**.
5. Rotate the **Tuning/Select control** until the required channel is highlighted. If the channel can be received the Ensemble (group of stations) name will appear. The radio will attempt to tune to one of the stations. The service database will be updated and the display will show the station name. The new station will be added to the list.
6. You can exit the Manual tune mode by pressing the **Menu/Back button**.

Note: Manual tuning can also be access simply by pressing and holding the **Tuning/Select control** while tuned to a DAB station with the normal radio station name display.

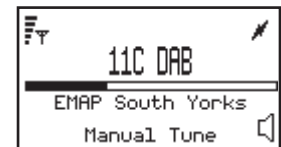
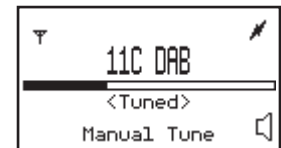
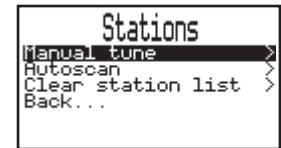
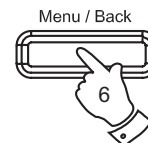
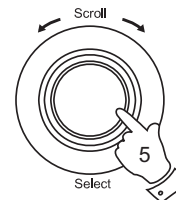
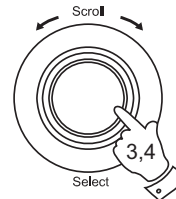
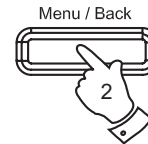
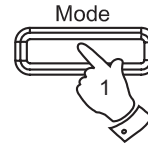

Secondary services - DAB

1. When transmitted, secondary services will be added to the service list and will appear indented beneath their associated primary service. They can be selected by pressing the **Tuning/Select control**.
2. The secondary service icon will appear in the display.
3. After a secondary broadcast has finished, the radio will automatically re-tune to the associated primary service.

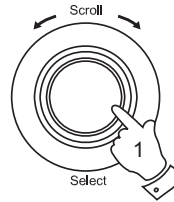

Display modes - DAB

Your radio has two display modes when listening to DAB. The default display is a full information display which shows station name, signal strength, program type, date and time, and a mains / battery status indicator. An optional full text display shows a full text display which the broadcaster may use to provide information related to their programmes.

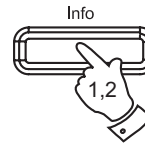

1. Press the **Info button** to display the full text mode. If there is more information than can be fitted into the display, rotate the **Tuning/Select control** to scroll the text up or down.
2. Press the **Info button** again to return to the full information display.



Using your radio's Pause Plus feature - DAB

How many times has your favourite radio station been interrupted by that phone call from a double glazing firm or someone selling that must have item? Sound familiar? With a single press of the **PAUSEplus** button you can put your favourite station on hold while you answer that important call. After the call or other important task is finished simply press the **PAUSEplus** button to return to your favourite station exactly where you left off so that you never miss a single word.

Radio stations can effectively be put on hold for typically 5 minutes.

Note the **PAUSEplus feature only operates on the DAB waveband.**



1. To place your radio in **PAUSEplus** mode simply press the **PAUSEplus** button, the sound from the loudspeaker will be muted. The length of the delay is shown on the right hand side of the display. The additional possible delay time will show on the left hand side.
 - If the radio is paused and the buffer becomes full then the radio will automatically start to play audio again.
2. To return to the radio station that you were listening to simply press the **PAUSEplus** button and your radio will continue playing from where you left off. The display will show the amount by which you are behind real time together with the remaining pause time.
3. To return to real-time listening press and release the **Tuning/Select control**, the radio will revert to the normal station name display.



Pause Plus Rewind and fastforward - DAB

1. As soon as you switch on your radio the **PAUSEplus** feature is working silently in the background so if, for example, you want to hear a news item again press the **Pauseplus button**. Press the **Rewind** or **Fast Forward button** or rotate the **Tuning control** to scroll forward or backward to the item you wish to listen to. The display will show the amount of time you have scrolled back together with the maximum time you can rewind back to.

Note the PAUSEplus rewind memory only starts when your radio is switched on.

2. To return to real-time listening press the **Tuning/Select control**.

3. The rewind memory capacity is approximately 5 minutes.

Note the PAUSEplus rewind feature only operates on the DAB waveband.

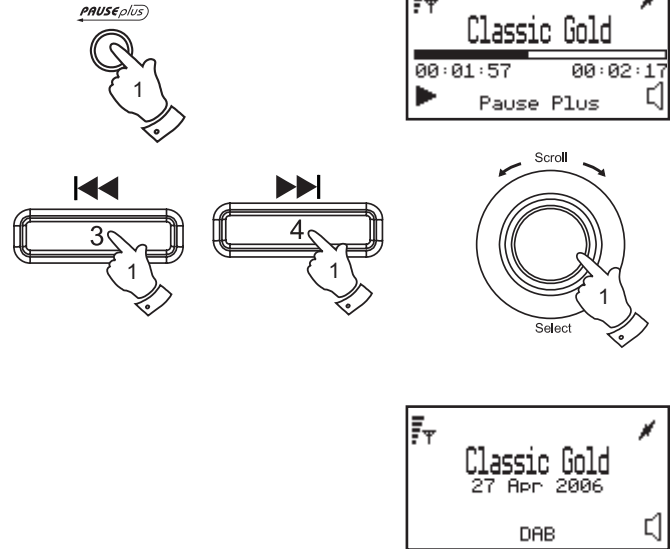

Using an SD memory card with your radio

An SD card can be used in your radio for recording, playing back previously recorded radio programs, or playing back MP2/MP3/WMA files transferred from a PC.

Depending on the radio station a 512MB SD card will give typically 8 - 16 hours of recording time. If you are using a new SD card ensure that it is formatted correctly (see page 28)

Many different brands and capacities of SD card are available. Your RD-41 can use cards up to 2 GB. However, there are many different card variants available and not all cards can be guaranteed to work in the RD-41. In this application there is no performance benefit in using high-speed cards. Note that the RD-41 is **not** compatible with very high capacity cards using the SDHC standard.

Inserting and removing a card

To insert an SD card into your radio carefully push the card into the SD card slot until it clicks. The card must be inserted gold contacts first and with the label side to the rear of the radio. The SD card slot is on the top left side of your radio.

To remove the card push the card in slightly and the eject mechanism will lift it slightly allowing easy removal.

Note: The SD card should not be removed during a recording as damage or corruption of files on the card may occur.

Recording a radio program (DAB only)

1. Tune to the DAB station you want to record.
2. Press the **Record button** to start recording. The record icon ● will flash in the display.
3. Press the **Record button** to stop recording. The recording will be saved on your SD card.
4. The recording showing the station name, date and time will be added to your playlist. (see page 31)

Note: Recordings can be set in advance using the Electronic Program Guide EPG (see page 35) or by setting up a timed recording (see page 17).

If your radio is not recording correctly check the following:

- The card is the correct format (reformat as described on page 28).
- The card has enough recording space available.
- The card has not become corrupted (possibly by removing the card during recording). Reformat the card if necessary.



Timed recording - DAB

Note: *Timer record is only available on DAB via SD card and is provided for personal use only.*

Your radio has twelve recording timers which can be set to activate at different times and with five different day options.

1. Insert an **SD card** with sufficient capacity for the required recording (approx. 64MB per 1 hour at 128 kbits/sec, or 2 hours at 64 kbits/sec).

Note: If you do not insert an SD card your recording will not take place and a warning "Memory card not detected" will be shown on the display.

2. Press the **Mode button** to enter *DAB* mode.
3. Press the **Menu/Back button** to enter the main DAB menu.
4. Rotate the **Tuning/Select control** until "Timed Recordings" is highlighted on the display. Press and release the **Tuning/Select control** to confirm the selection.
5. Rotate the **Tuning/Select control** until "Recording 1 of 12" is highlighted on the display. Press and release the **Tuning/Select control** to enter setup.
6. Rotate the **Tuning/Select control** to select the required timer (1-12). Press and release the **Tuning/Select control**.

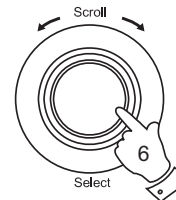
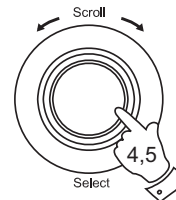
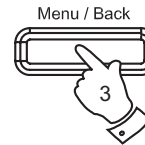
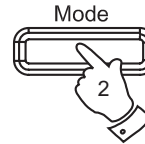

continued on next page

7. Rotate the **Tuning/Select control** until the day option is highlighted on the display. To adjust the day option setting press the **Select/Tuning control**. By default, record timers are be set to "Off".

- Each of the 12 timers can be set to one of the following modes:-
 - Off - Will disable the timer
 - Once - Will record at one time only
 - Every day - Will record every day
 - Weekly - Will record once every week
 - Weekdays - Will record on weekdays (Monday - Friday)
 - Weekends - Will record on Saturday and Sunday

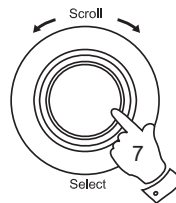

Timer set to Once

1. Rotate the **Tuning/Select control** until "Once" is highlighted on the display. Press and release the **Tuning/Select control**.
2. Rotate the **Tuning/Select control** until the date is highlighted on the display. Press and release the **Tuning/Select control** to enter date setup.
3. Rotate the **Tuning/Select control** to select the required date. Press and release the **Tuning/Select control**.

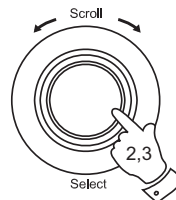
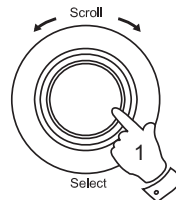

Note: Your radio allows recording to be scheduled 60 days ahead of current date.

continued on next page

4. Rotate the **Tuning/Select control** until the hour digits are highlighted on the display. Press and release the **Tuning/Select control**.

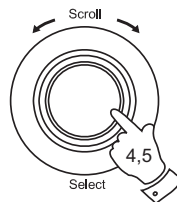

```
Timed Recordings
Recordings 1 of 12
Once
26/04/06 Wed
15:30 for 00:30
Classic Gold
Back...
```

5. Rotate the **Tuning/Select control** to select the required hour. Press and release the **Tuning/Select control**.

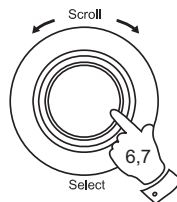

```
Timed Recordings
Recordings 1 of 12
Once
26/04/06 Wed
16:30 for 00:30
Classic Gold
Back...
```

6. Rotate the **Tuning/Select control** until the minute digits are highlighted on the display. Press and release the **Tuning/Select control**.

7. Rotate the **Tuning/Select control** to select the required minute. Press and release the **Tuning/Select control**.

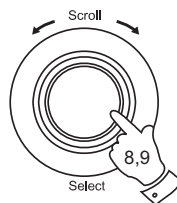

```
Timed Recordings
Recordings 1 of 12
Once
26/04/06 Wed
16:30 for 00:30
Classic Gold
Back...
```

8. Rotate the **Tuning/Select control** until the duration hour digits are highlighted on the display. Press and release the **Tuning/Select control**.

9. Rotate the **Tuning/Select control** to select the required hour. Press and release the **Tuning/Select control**.

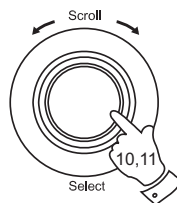

```
Timed Recordings
Recordings 1 of 12
Once
26/04/06 Wed
16:30 for 00:30
Classic Gold
Back...
```

10. Rotate the **Tuning/Select control** until the duration minute digits are highlighted on the display. Press and release the **Tuning/Select control**.

11. Rotate the **Tuning/Select control** to select the required minute. Press and release the **Tuning/Select control**.

continued on next page

12. Rotate the **Tuning/Select control** until the station is highlighted on the display. Press and release the **Tuning/Select control**.
13. Rotate the **Tuning/Select control** to select the required station. Press and release the **Tuning/Select control**.
14. Press the **Menu/Back button** or select the "Back..." option to exit back a menu or screen.

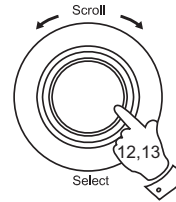

Timer set to Every day

1. Rotate the **Tuning/Select control** until "**Every day**" is highlighted on the display. Press and release the **Tuning/Select control**.
2. Rotate the **Tuning/Select control** until the hour digits are highlighted on the display. Press and release the **Tuning/Select control**.
3. Rotate the **Tuning/Select control** to select the required hour. Press and release the **Tuning/Select control**.
4. Rotate the **Tuning/Select control** until the minute digits are highlighted on the display. Press and release the **Tuning/Select control**.
5. Rotate the **Tuning/Select control** to select the required minute. Press and release the **Tuning/Select control**.

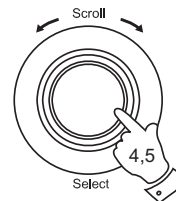
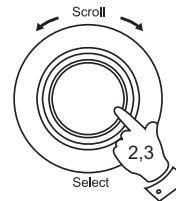
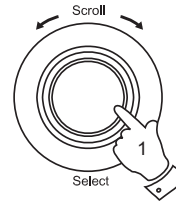

continued on next page

6. Rotate the **Tuning/Select control** until the duration hour digits are highlighted on the display. Press and release the **Tuning/Select control**.
7. Rotate the **Tuning/Select control** to select the required hour. Press and release the **Tuning/Select control**.
8. Rotate the **Tuning/Select control** until the duration minute digits are highlighted on the display. Press and release the **Tuning/Select control**.
9. Rotate the **Tuning/Select control** to select the required minute. Press and release the **Tuning/Select control**.
10. Rotate the **Tuning/Select control** until the station is highlighted on the display. Press and release the **Tuning/Select control**.
11. Rotate the **Tuning/Select control** to select the required station. Press and release the **Tuning/Select control**.
12. Press the **Menu/Back button** or select the "Back..." option to exit back a menu or screen.

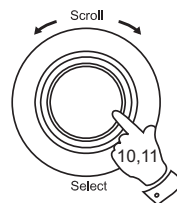
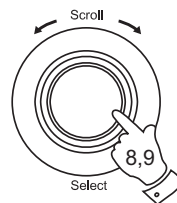
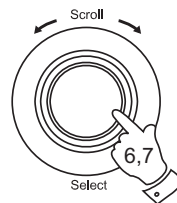

continued on next page

Timer set to Weekly

1. Rotate the **Tuning/Select control** until "Weekly" is highlighted on the display. Press and release the **Tuning/Select control**.
2. Rotate the **Tuning/Select control** until the week day is highlighted on the display. Press and release the **Tuning/Select control**.
3. Rotate the **Tuning/Select control** to select the required week day. Press and release the **Tuning/Select control**.
4. Rotate the **Tuning/Select control** until the hour digits are highlighted on the display. Press and release the **Tuning/Select control**.
5. Rotate the **Tuning/Select control** to select the required hour. Press and release the **Tuning/Select control**.
6. Rotate the **Tuning/Select control** until the minute digits are highlighted on the display. Press and release the **Tuning/Select control**.
7. Rotate the **Tuning/Select control** to select the required minute. Press and release the **Tuning/Select control**.

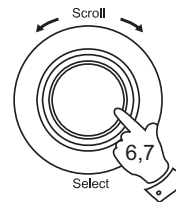
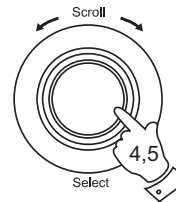
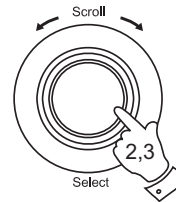
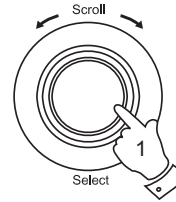

continued on next page

8. Rotate the **Tuning/Select control** until the duration hour digits are highlighted on the display. Press and release the **Tuning/Select control**.
9. Rotate the **Tuning/Select control** to select the required hour. Press and release the **Tuning/Select control**.
10. Rotate the **Tuning/Select control** until the duration minute digits are highlighted on the display. Press and release the **Tuning/Select control**.
11. Rotate the **Tuning/Select control** to select the required minute. Press and release the **Tuning/Select control**.
12. Rotate the **Tuning/Select control** until the station is highlighted on display. Press and release the **Tuning/Select control**.
13. Rotate the **Tuning/Select control** to select the required station. Press and release the **Tuning/Select control**.
14. Press the **Menu/Back button** or select the "Back..." option to exit back a menu or screen.

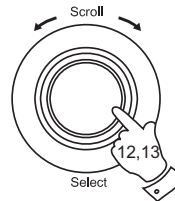
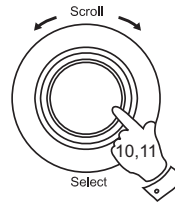
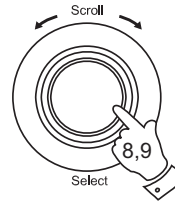

continued on next page

Timer set to Weekdays

1. Rotate the **Tuning/Select control** until "weekdays" is highlighted on the display. Press and release the **Tuning/Select control**.
2. Rotate the **Tuning/Select control** until the hour digits are highlighted on the display. Press and release the **Tuning/Select control**.
3. Rotate the **Tuning/Select control** to select the required hour. Press and release the **Tuning/Select control**.
4. Rotate the **Tuning/Select control** until the minute digits are highlighted on the display. Press and release the **Tuning/Select control**.
5. Rotate the **Tuning/Select control** to select the required minute. Press and release the **Tuning/Select control**.
6. Rotate the **Tuning/Select control** until the duration hour digits are highlighted on the display. Press and release the **Tuning/Select control**.
7. Rotate the **Tuning/Select control** to select the required hour. Press and release the **Tuning/Select control**.

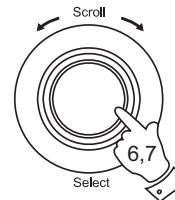
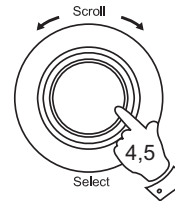
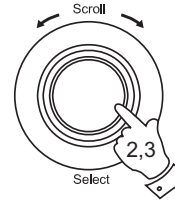
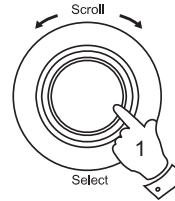

continued on next page

8. Rotate the **Tuning/Select control** until the duration minute digits are highlighted on the display. Press and release the **Tuning/Select control**.
9. Rotate the **Tuning/Select control** to select the required minute. Press and release the **Tuning/Select control**.
10. Rotate the **Tuning/Select control** until the station is highlighted on the display. Press and release the **Tuning/Select control**.
11. Rotate the **Tuning/Select control** to select the required station. Press and release the **Tuning/Select control**.
12. Press the **Menu/Back button** or select the "Back..." option to exit back a menu or screen.

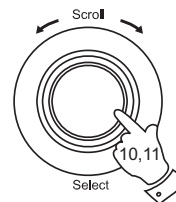
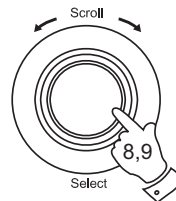

Timer set to weekends

1. Rotate the **Tuning/Select control** until "Weekends" is highlighted on the display. Press and release the **Tuning/Select control**.
2. Rotate the **Tuning/Select control** until the hour digits are highlighted on the display. Press and release the **Tuning/Select control**.
3. Rotate the **Tuning/Select control** to select the hour digits. Press and release the **Tuning/Select control**.

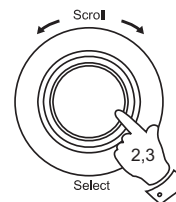
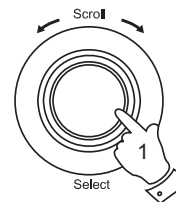

continued on next page

4. Rotate the **Tuning/Select control** until the minute digits are highlighted on the display. Press and release the **Tuning/Select control**.
5. Rotate the **Tuning/Select control** to select the required minute. Press and release the **Tuning/Select control**.
6. Rotate the **Tuning/Select control** until the duration hour digits are highlighted on the display. Press and release the **Tuning/Select control**.
7. Rotate the **Tuning/Select control** to select the required hour. Press and release the **Tuning/Select control**.
8. Rotate the **Tuning/Select control** until the duration minute digits are highlighted on the display. Press and release the **Tuning/Select control**.
9. Rotate the **Tuning/Select control** to select the required minute. Press and release the **Tuning/Select control**.

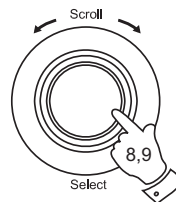
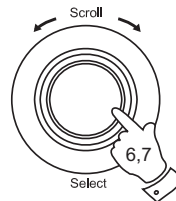
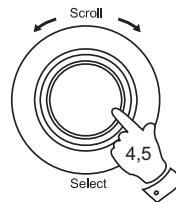

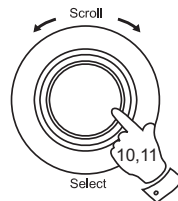

continued on next page

10. Rotate the **Tuning/Select control** until the station is highlighted.
Press and release the **Tuning/Select control**.
11. Rotate the **Tuning/Select control** to select the required station.
Press and release the **Tuning/Select control**.
12. Press the **Menu/Back button** or select the "Back..." option to exit
back a menu or screen.



Note: Once the timed record function has been set the timer record icon  will appear in the display. The timed record icon will flash for the duration of the recording.

- If no SD card is inserted the warning message "Memory card not detected" will appear.
- If your radio is in standby mode at the selected time the recording icon will flash  and the timed recording will be performed silently in the background.
- If your radio is switched on at the selected time the recording icon will flash  and the radio will tune to the station specified for the timed recording.

SD Card Format

Formatting your SD card erases any previously recorded files. It also allows an SD card formatted on another device to be re-formatted for use on your radio. The SD card can be formatted in DAB, FM and Playlist mode.

1. Insert an SD card into the slot.
2. Press the **Menu/Back button** to enter the main menu.
3. Rotate the **Tuning/Select control** until "Settings" is highlighted on the display. Press and release the **Tuning/Select control** the settings menu will appear on the display.
4. Rotate the **Tuning/Select control** until "Format memory card" is highlighted on the display. Press and release the **Tuning/Select control**.

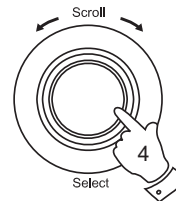
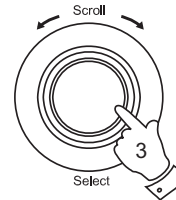
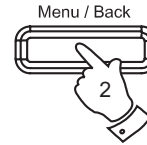

continued on next page

5. Rotate the **Tuning Select control** until "FORMAT MEMORY CARD" is highlighted on the display.
6. Press the **Tuning/Select control**, the screen will show "card formatting" and the disc will be formatted and the display will show "SD card formatted" and the radio will return to the previous screen.
7. If you do not wish to format your SD card rotate the **Tuning/Select control** until "Back" is selected on the display or press the **Menu/Back button**.
8. The radio will return to the previous screen.

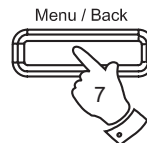
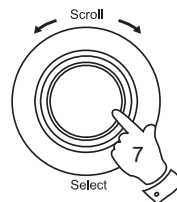
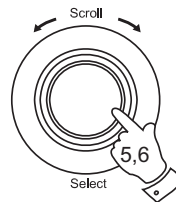

Dynamic Range Control (DRC) settings - DAB

DRC can make quieter sounds easier to hear when your radio is used in a noisy environment.

1. Press the **Mode button** until the DAB waveband is selected.
2. Press the **Menu/Back button**, the main **Menu screen** will be selected.
3. Rotate the **Tuning/Select control** until "Settings" is highlighted on the display. Press and release the **Tuning/Select control**.
4. Rotate the **Tuning/Select control** until "Radio" is highlighted on the display. Press and release the **Tuning/Select control**.
5. Rotate the **Tuning/Select control** until "DAB DRC" is highlighted on the display. Press and release the **Tuning/Select control**.
6. To enable DRC rotate the **Tuning/Select control** until "Auto" is shown on the display. To disable DRC rotate the **Tuning/Select control** until "Disabled" is shown on the display. Press and release the **Tuning/Select control**.
7. Press the **Menu/Back button** or select the "Back..." option to exit back a menu or screen.

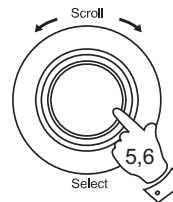
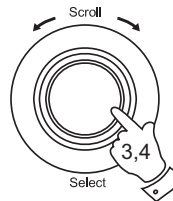
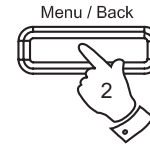
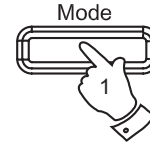

Note: Not all DAB broadcasts are able to use the DRC function. If the broadcast does not support DRC, then the DRC setting in the radio will have no effect.

File playback

The playlist mode displays the files on the current memory card. It displays the recording name on the first line and the file creation details on the second line.

1. Ensure your SD card is inserted correctly (the label must be towards the back of the radio with gold contacts inserted first).
2. Press the **Mode button** until the Play list mode is selected
3. A list of the recordings on your SD card will be displayed.
4. You can scroll through the list using the **Tuning/Select control**.

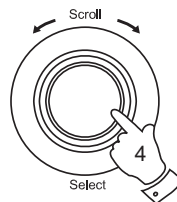
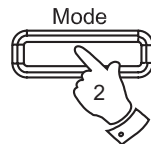

To play all files

1. Press the **Play/Pause button**.
2. Repeatedly press the **Repeat mode button** until "ALL" is shown on the display.
3. All your playlist files will be played in list order from the first selected file.

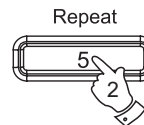
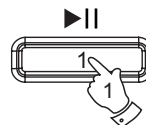

Note: The RD-41 can playback MP3 and WMA files encoded at up to 192k bits per second. Files using higher rates may sometimes be playable.

continued on next page

Repeat all files

1. Press the **Play/Pause button**.
2. Repeatedly press the **Repeat mode button** until "ALL" is shown on the display.
3. All your playlist files will be played in list order. The entire list will be repeated from the selected file.

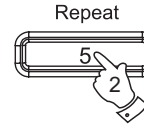
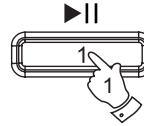

Play files in random order

1. Press the **Play/Pause button**.
2. Repeatedly press the **Repeat mode button** until "RANDOM" is shown on the display.
3. All your playlist files will be played in random order.

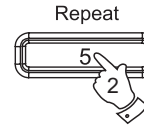
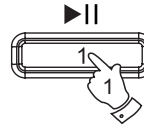

Repeat files in random order

1. Press the **Play/Pause button**.
2. Repeatedly press the **Repeat mode button** until "RANDOM" is shown on the display.
3. Your playlist files will be repeated in random order.

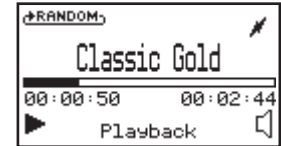
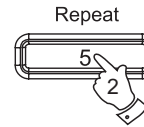
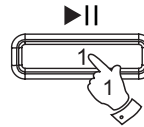

continued on next page

Play single files

1. Press the **Play/Pause button**.
2. Repeatedly press the **Repeat mode button** until "SINGLE" is shown on the display.
3. The selected file will be played once.

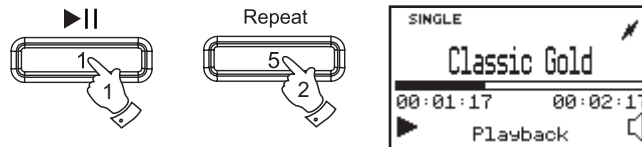

Repeat a single file

1. Press the **Play/Pause button**.
2. Repeatedly press the **Repeat mode button** until "↻SINGLE" is shown on the display.
3. The selected file will be played repeatedly.

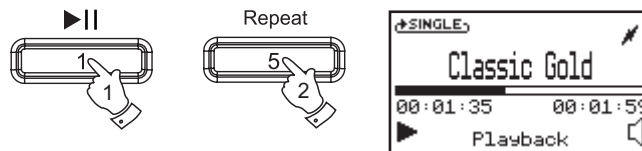

Fast forward files

1. Press the **Fast Forward button** to skip to the next track in the playlist.
2. While a track is playing press and hold down the **Fast Forward button** until the desired part of the track is reached.

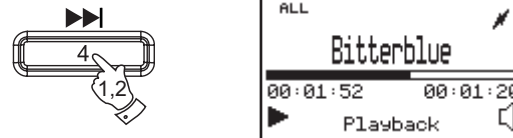

continued on next page

Rewind files

1. Press the **Rewind button** to skip back to the previous track in the playlist.
2. While a track is playing press and hold down the **Rewind button** until the desired part of the track is reached.

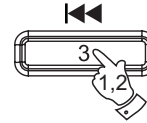

Stop playing files

1. Press the **Stop button** and the track will stop playing and the display will return to the playlist.

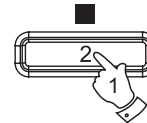

Delete files

1. From the playlist menu rotate the **Tuning/Select control** until the track for deletion is highlighted on the display.
2. Press the **Delete button** the display will prompt you to delete this file.
3. Rotate the **Tuning/Select control** until "DELETE THIS FILE" is highlighted. Then press the **Tuning/Select control**. The selected track will be deleted from the SD card.

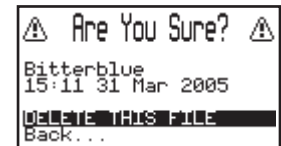
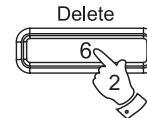
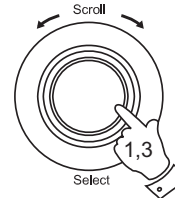

To exit the playlist menu

1. To exit the playlist mode, stop playback and then press the **Mode button** to change to either DAB or FM mode.

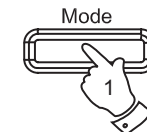

Using the Electronic Programme Guide (EPG)

The Electronic Programme Guide (EPG) provides start/stop times and program information similar to that provided for digital TV broadcasts. The EPG typically provides program information for up to seven days in advance.

When used for the first time your radio's EPG will be empty. After a few minutes use in DAB mode the guide will begin to fill up with information for programs contained within the currently tuned DAB multiplex (where broadcast). This is indicated by the flashing EPG icon. The EPG icon will stop flashing when data for the currently selected station has been completed.

When powered via the AC adaptor and set to standby mode your radio will automatically search all available multiplexes and download EPG data in the background.

Note: Not all stations or multiplexes have EPG data available. Recording using the EPG requires a suitable SD card to be installed in the radio (see page 16).

1. Press the **Mode button** until the DAB waveband is selected.
2. Press the **EPG button**. This displays the programme guide for the current station. The current program on that station will have > symbol displayed next to it.
3. Rotate the **Tuning/Select control** to scroll between the various stations. To select the desired station press the **Tuning/Select control**.
4. Rotate the **Tuning/Select control** to scroll down the various programs until the desired program is highlighted.

continued on next page

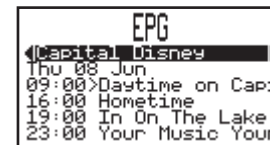
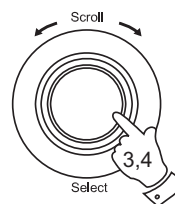
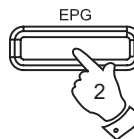
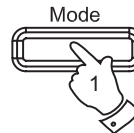

5. The EPG may contain additional information describing the program. To view this information press the **Tuning/Select control**.
6. If there is more text than can fit onto the screen rotate the **Tuning/Select control** to scroll the display.
7. Press the **Menu/Back button** to view the program listing.
8. If you wish to record the program press the **Record button**. The record symbol ● will appear next to the selected program. The selected program will be added to the Record timer list.
9. To cancel a recording scroll to the station set to record and press the **Record button**. The record symbol ● will be removed from the display.
10. Programs set to record in EPG also appear in list of timed recordings. Up to 12 different timed recordings are permitted.

Note: Once the EPG recording has been set the timer record icon  will appear in the display. The timed record icon will flash for the duration of the recording.

- If your radio is in standby mode at the selected time the recording icon will flash ● and the timed recording will be performed silently in the background.
- If your radio is switched on at the selected time the recording icon will flash ● and the radio will tune to the station specified for the timed recording.

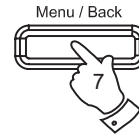
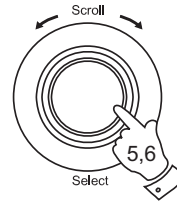

Operating your radio - FM auto search

1. Fully extend the telescopic aerial.
2. Press the **Power/Standby button** to switch on your radio.
3. Press the **Mode button** until the FM mode is selected.
4. Press the **Menu/Back button**, the main **Menu screen** will be selected.
5. Rotate the **Tuning/Select control** until "Stations" is highlighted on the display. Press and release the **Tuning/Select control**.
6. Rotate the **Tuning/Select control** until "Autoscan" is highlighted on the display. Press and release the **Tuning/Select control**.
7. Rotate the **Tuning/Select control** until "FM band" is highlighted on the display.
8. Press and release the **Tuning/Select control**, a station scan of the FM waveband will be carried out and your radio will play the first station in the FM station list.
9. The scan can be cancelled at any time by pressing the **Menu/Back button**.

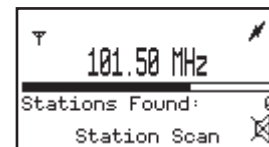
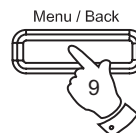
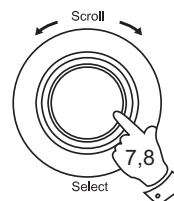
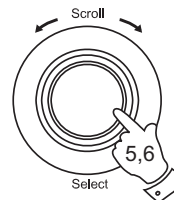
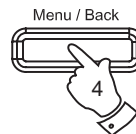
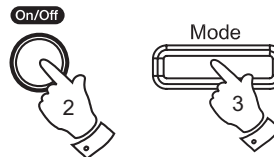

Operating your radio - FM manual tune

1. Fully extend the telescopic aerial.
2. Press the **Power/Standby button** to switch on your radio.
3. Press the **Mode button** until the FM mode is selected.
4. Press the **Menu/Back button**, the main FM Menu screen will be selected.
5. Rotate the **Tuning/Select control** until "Stations" is highlighted on the display. Press and release the **Tuning/Select control**.
6. Rotate the **Tuning/Select control** until "Manual tune" is highlighted on the display. Press and release the **Tuning/Select control**.
7. Rotate the **Tuning/Select control** clockwise to tune up in frequency or rotate the **Tuning control** anti-clockwise to tune down in frequency. The frequency will increase or decrease in 50 kHz steps.
8. Adjust the **Volume, Bass and Treble controls** to the required settings.
9. To exit the clock setup press the **Menu/Back button**.

Note: Manual tuning can also be accessed simply by pressing and holding the **Tuning/Select control** while tuned to an FM station with the radio station name / frequency displayed.

If you need any further advice, please call our Technical Helpline on :-
020 8758 0338 (Mon-Fri)

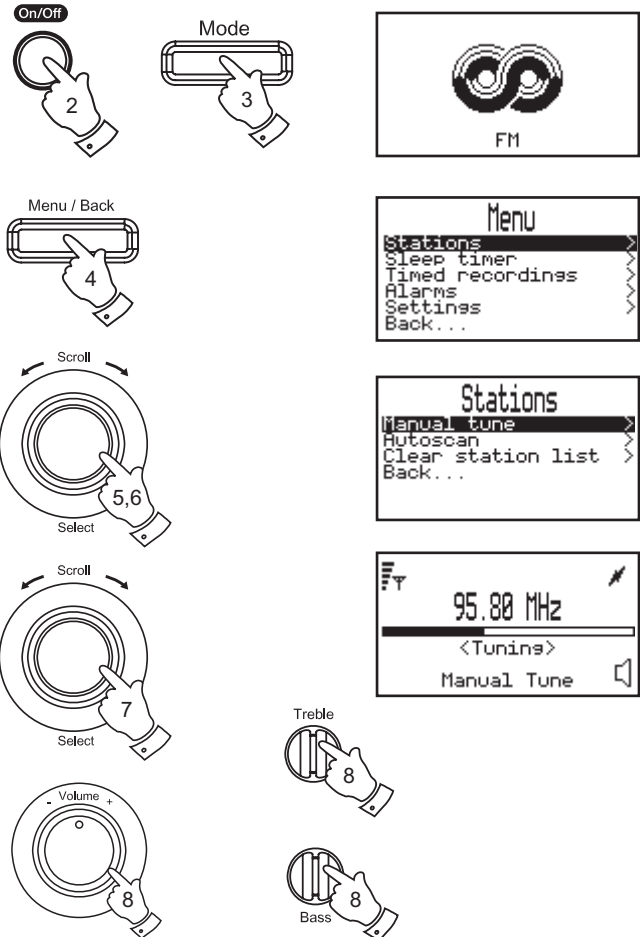

Presetting stations - DAB and FM

There are 6 memory presets for each of the 2 wavebands.

1. Press the **Power/Standby button** switch on the radio.
2. Tune to the required station as previously described.
3. Press and hold down the required **Preset button** until the display shows "Preset stored". The station will be stored under the chosen preset button. Repeat this procedure for the remaining presets.
4. Stations stored in preset memories may be overwritten by following the above procedure.

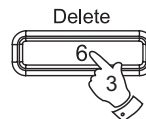
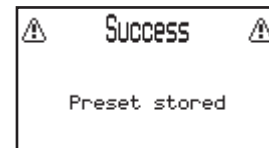

Recalling a preset station - DAB and FM

1. Press the **Power/Standby button** to switch on the radio.
2. Select the required waveband.
3. Momentarily press the required **Preset button**, your radio will tune to the station stored in preset memory.

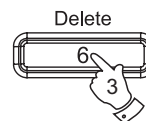

Clock settings

Your radio's clock and date is by default automatically set when first tuned to a DAB station. The clock display will be 24hr format. You have two clock setting options, you can either select the clock to automatically update from DAB or FM broadcasts, or you can set the clock manually.

Setting the clock automatically

1. Press the **Mode button** until the desired waveband is reached.
2. Press the **Menu/Back button**, the main Menu screen will be selected.
3. Rotate the **Tuning/Select control** until "Settings" is highlighted on the display. Press and release the **Tuning/Select control**.
4. Rotate the **Tuning/Select control** until "Clock" is highlighted on the display. Press and release the **Tuning/Select control**.
5. Press and release the **Tuning/Select control** to enter the clock options.
6. Rotate the **Tuning/Select control** until "Auto update" is highlighted on the display. Press and release the **Tuning/Select control**.
7. To exit the clock setup press the **Menu/Back button** or select the "Back..." option to exit back a menu or screen.

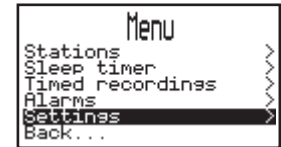
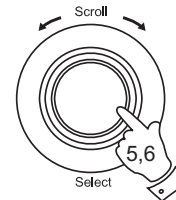
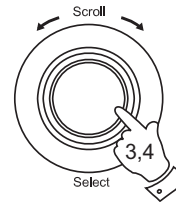
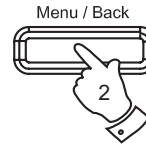
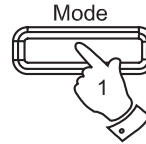

Setting the clock manually

1. Press the **Mode button** until the desired waveband is reached.
2. Press the **Menu/Back button**, the main Menu screen will be selected.
3. Rotate the **Tuning/Select control** until "Settings" is highlighted on the display. Press and release the **Tuning/Select control**.
4. Rotate the **Tuning/Select control** until "Clock" is highlighted on the display. Press and release the **Tuning/Select control**.
5. Press and release the **Tuning/Select control** to enter the clock set options.
6. Rotate the **Tuning/Select control** until "Manual set" is selected on the display. Press and release the **Tuning/Select control**.
7. Rotate the **Tuning/Select control** to highlight the hour digits. Press and release the **Tuning/Select control**.
8. Rotate the **Tuning/Select control** to select the required hour. Press and release the **Tuning/Select control**.

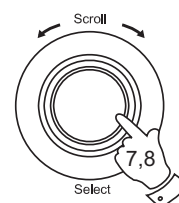
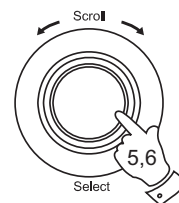
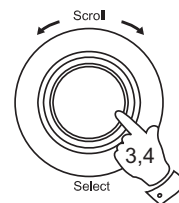
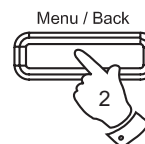
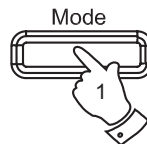

continued on next page

Setting the clock manually cont.

9. Rotate the **Tuning/Select control** to highlight the minute digits. Press and release the **Tuning/Select control** to adjust the minutes.
10. Rotate the **Tuning/Select control** to select the required minute. Press and release the **Tuning/Select control**.
11. Rotate the **Tuning/Select control** to highlight the GMT offset. Press and release the **Tuning/Select control** to adjust the GMT offset. GMT offset is used to control EPG recordings and is only required when the clock is set manually.
12. Rotate the **Tuning/Select control** to select the required offset. Press and release the **Tuning/Select control**.
13. Rotate the **Tuning/Select control** to highlight the date. Press and release the **Tuning/Select control** to adjust the date setting.
14. Rotate the **Tuning/Select control** to select the required date. Press and release the **Tuning/Select control** to confirm the selection.
15. Press the **Menu/Back button** or select the "Back..." option to exit back a menu or screen. Repeat twice more to exit the menu completely.

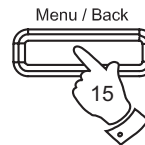
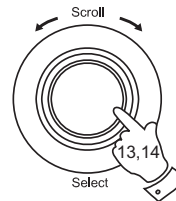
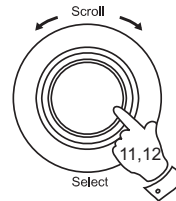
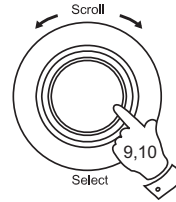

Alarms

Your radio has twelve separate alarms which can be set to wake you to either radio, playlist or beep type alarm. Each alarm can be set to sound once, every day, weekly, weekdays or weekends. In the event of a power interruption your radio has a built in memory chip that will maintain all your alarm settings when the power is restored.

Note: Alarm time format (24 hour). The clock must have been set automatically or manually before alarms will operate.

To exit the alarm setup at any time press the **Menu/back button**.

1. Press the **Menu/Back button**, the main Menu screen will be selected.
2. Rotate the **Tuning/Select control** until "Alarms" is highlighted on the display. Press and release the **Tuning/Select control** to enter the alarm setup.
3. Rotate the **Tuning/Select control** until "Alarm 1 of 12" is highlighted on the display. Press and release the **Tuning/Select control** to enter setup.

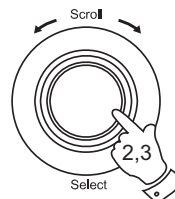
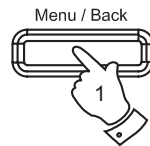

continued on next page

Alarms cont.

4. Rotate the **Tuning/Select control** to select the required alarm (1 - 12). Press and release the **Tuning/Select control**.
5. Rotate the **Tuning/Select control** until the alarm day option is highlighted on the display. The default day option will be "Off". Press and release the **Tuning/Select control** to enter setup.

- Your alarm can be set to sound once, every day, weekly, weekdays, weekends or off.

Off	- Will disable this alarm
Once	- Will sound at one time only
Every day	- Will sound everyday
Weekly	- Will sound on one day each week
Weekdays	- Will sound on weekdays (Monday - Friday)
Weekends	- Will sound only on Saturday and Sunday

6. Rotate the **Tuning/Select control** to select the required alarm day option above.

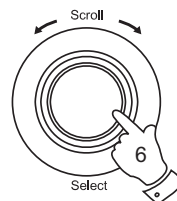
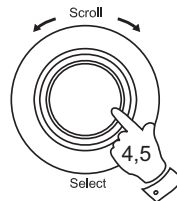

continued on next page

Alarm set to Once

1. Rotate the **Tuning/Select control** until "Once" is highlighted on the display. Press and release the **Tuning/Select control**.
2. Rotate the **Tuning/Select control** until the date is highlighted on the display. Press and release the **Tuning/Select control** to enter date setup.
3. Rotate the **Tuning/Select control** to select the required date. Press and release the **Tuning/Select control**.
4. Rotate the **Tuning/Select control** until the hour digits are highlighted on the display. Press and release the **Tuning/Select control**.
5. Rotate the **Tuning/Select control** to select the required hour. Press and release the **Tuning/Select control**.
6. Rotate the **Tuning/Select control** until the minute digits are highlighted on the display. Press and release the **Tuning/Select control**.
7. Rotate the **Tuning/Select control** to select the required minute. Press and release the **Tuning/Select control**.

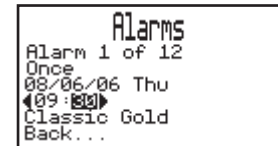
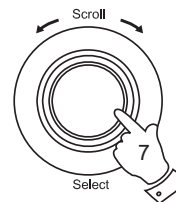
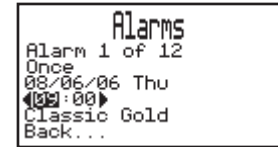
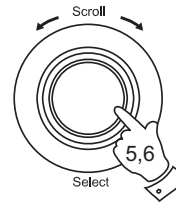
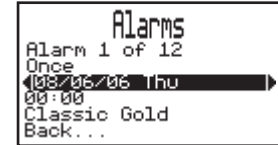
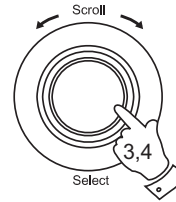
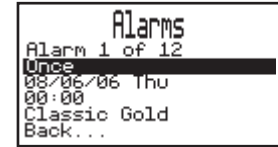
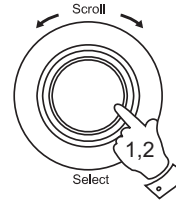

continued on next page

8. Rotate the **Tuning/Select control** until the alarm mode is highlighted on the display. Press the **Tuning/Select control**.
9. Rotate the **Tuning/Select control** to select required alarm mode. Your alarm can be set to either buzzer, station name or track from playlist. Press and release the **Tuning/Select control**.
10. Press the **Menu/Back button** or select the "Back..." option to exit back a menu or screen.

Alarm set to Every day

1. Rotate the **Tuning/Select control** until "Every day" is highlighted on the display. Press and release the **Tuning/Select control**.
2. Rotate the **Tuning/Select control** until the hour digits are highlighted on the display. Press and release the **Tuning/Select control**.
3. Rotate the **Tuning/Select control** to select the required hour. Press and release the **Tuning/Select control**.
4. Rotate the **Tuning/Select control** until the minute digits are highlighted on the display. Press and release the **Tuning/Select control**.
5. Rotate the **Tuning/Select control** to select the required minute. Press and release the **Tuning/Select control**.

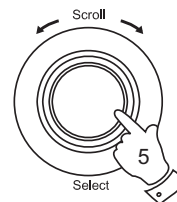
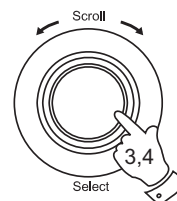
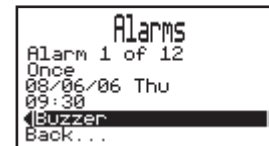
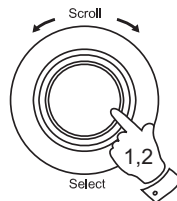
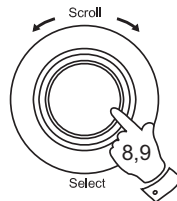

continued on next page

- Rotate the **Tuning/Select control** until the alarm mode is highlighted on the display. Press the **Tuning/Select control**.
- Rotate the **Tuning/Select control** to select required alarm mode. Your alarm can be set to either buzzer, station name or track from playlist. Press and release the **Tuning/Select control**.
- Press the **Menu/Back button** or select the "Back..." option to exit back a menu or screen.

Alarm set to Weekly

- Rotate the **Tuning/Select control** until "Weekly" is highlighted on the display. Press and release the **Tuning/Select control**.
- Rotate the **Tuning/Select control** until the day is highlighted on the display. Press and release the **Tuning/Select control** to enter day setup.
- Rotate the **Tuning/Select control** to select the required day. Press and release the **Tuning/Select control**.
- Rotate the **Tuning/Select control** until the hour digits are highlighted on the display. Press and release the **Tuning/Select control**.
- Rotate the **Tuning/Select control** to select the required hour. Press and release the **Tuning/Select control**.

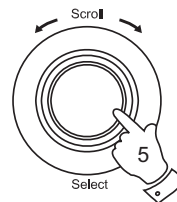
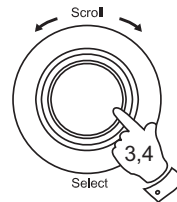
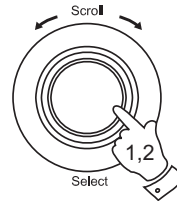
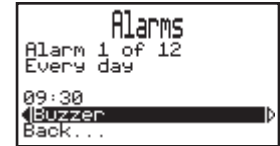
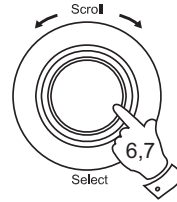

continued on next page

6. Rotate the **Tuning/Select control** until the minute digits are highlighted on the display. Press and release the **Tuning/Select control**.
7. Rotate the **Tuning/Select control** to select the required minute. Press and release the **Tuning/Select control**.
8. Rotate the **Tuning/Select control** until the alarm mode is highlighted on the display. Press the **Tuning/Select control**.
9. Rotate the **Tuning/Select control** to select required alarm mode. Your alarm can be set to either buzzer, station name or track from playlist. Press and release the **Tuning/Select control**.
10. Press the **Menu/Back button** or select the "Back..." option to exit back a menu or screen.

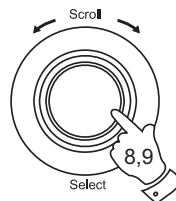
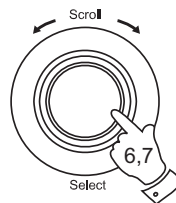

Alarm set to Weekdays

1. Rotate the **Tuning/Select control** until "Weekdays" is highlighted on the display. Press and release the **Tuning/Select control**.
2. Rotate the **Tuning/Select control** until the hour digits are highlighted on the display. Press and release the **Tuning/Select control**.

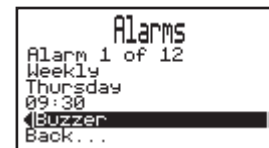
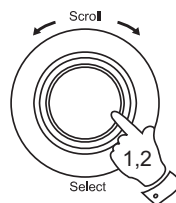

continued on next page

3. Rotate the **Tuning/Select control** to select the required hour.
Press and release the **Tuning/Select control**.
4. Rotate the **Tuning/Select control** until the minute digits are highlighted on the display. Press and release the **Tuning/Select control**.
5. Rotate the **Tuning/Select control** to select the required minute.
Press and release the **Tuning/Select control**.
6. Rotate the **Tuning/Select control** until the alarm mode is highlighted on the display. Press the **Tuning/Select control**.
7. Rotate the **Tuning/Select control** to select required alarm mode.
Your alarm can be set to either buzzer, station name or track from playlist. Press and release the **Tuning/Select control**.
8. Press the **Menu/Back button** or select the "Back..." option to exit back a menu or screen.

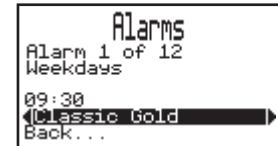
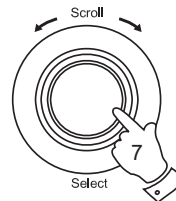
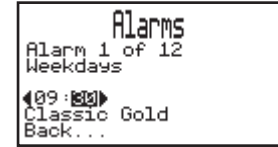
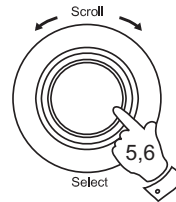
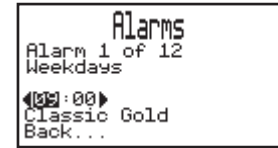
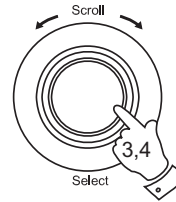

continued on next page

Alarm set to Weekends

1. Rotate the **Tuning/Select control** until "Weekends" is highlighted on the display. Press and release the **Tuning/Select control**.
2. Rotate the **Tuning/Select control** until the hour digits are highlighted on the display. Press and release the **Tuning/Select control**.
3. Rotate the **Tuning/Select control** to select the required hour. Press and release the **Tuning/Select control**.
4. Rotate the **Tuning/Select control** until the minute digits are highlighted on the display. Press and release the **Tuning/Select control**.
5. Rotate the **Tuning/Select control** to select the required minute. Press and release the **Tuning/Select control**.
6. Rotate the **Tuning/Select control** until the alarm mode is highlighted on the display. Press and release the **Tuning/Select control**.
7. Rotate the **Tuning/Select control** to select required alarm mode. Your alarm can be set to either buzzer, station name or track from playlist. Press and release the **Tuning/Select control**.
8. Press the **Menu/Back button** or select the "Back..." option to exit back a menu or screen.

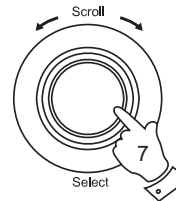
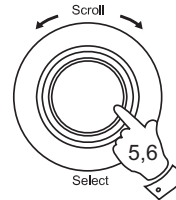
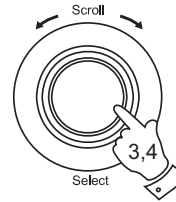
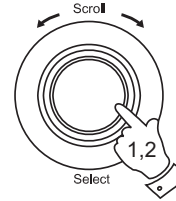

continued on next page

Alarms cont.

- Once an alarm has been set the radio alarm or buzzer alarm icon will appear in the display. The alarm will sound at the selected times and will sound for 60 minutes unless cancelled. While the alarm is sounding the alarm icon will flash in the display.

Cancelling alarms

- Whilst an alarm is sounding it can be cancelled by pressing the **On/Standby button or the Tuning/Select control**. Unless the alarm was set to sound once only, it will then sound again at the next scheduled time.

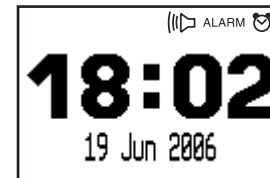
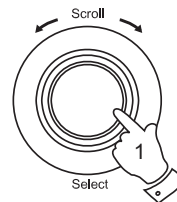

Snooze function

- The radio or buzzer alarm can be silenced for 7 minutes by pressing **any of the preset buttons 1-6, or any button except the On/Standby button**. This sequence can be repeated during the 60 minute alarm period.
- While the alarm is temporarily suspended the Snooze symbol will appear in the display.
- In order to cancel the Snooze function, press the **On/Standby button** once.

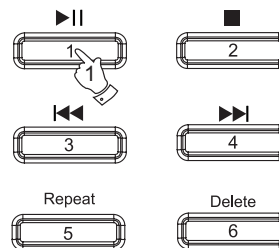

Sleep timer

Your radio can be set to turn off after a preset time has elapsed. The sleep timer can be adjusted between 5 and 90 minutes in 5 minute increments.

1. Press the **Mode button** until the desired waveband is selected.
2. Press the **Menu/Back button**, the main Menu screen will be selected.
3. Rotate the **Tuning/Select control** until "Sleep timer" is highlighted on the display. Press and release the **Tuning/Select control**. "Off" will show on the display.
4. Press and release the **Tuning/Select control**.
5. Rotate the **Tuning/Select control** to select the desired sleep time from the range 5 minutes up to 90 minutes, or select OFF to permanently cancel the sleep timer. Press and release the **Tuning/Select control** to confirm selection.
6. Press the **Menu/back button** or select the "Back..." option to exit the sleep timer.
7. Your radio will switch off after the preset sleep time has elapsed. To cancel the sleep function before the preset time has elapsed, press and release the **Power/standby button**.

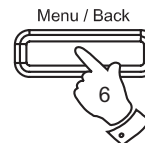
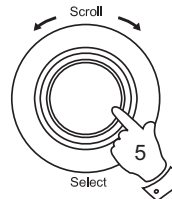
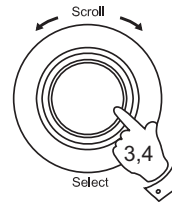
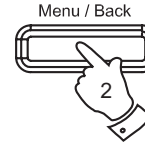
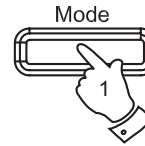

Clear station list

Clearing the station list will clear both the FM and DAB stations from the station data base.

1. Press the **Mode button** until the desired waveband is selected.
2. Press the **Menu/Back button**, the main Menu screen will be selected.
3. Rotate the **Tuning/Select control** until "Stations" is highlighted on the display. Press and release the **Tuning/Select control**.
4. Rotate the **Tuning/Select control** until "Clear station list" is highlighted on the display. Press and release the **Tuning/Select control**.
5. The radio will display "Are You Sure?" Rotate the **Tuning/Select control** until "CLEAR STATION LIST" is highlighted on the display. Press and release the **Tuning/Select control**.
6. The stations in the station data base will be deleted.
7. If you do not wish to clear the station list press the **Menu/Back button** or select the "Back..." option to exit back a menu or screen.

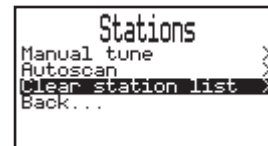
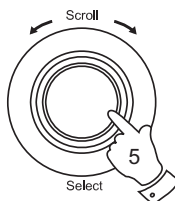
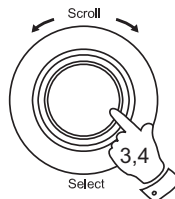
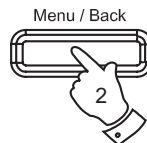
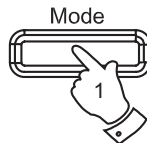

Audio mode FM

On the FM band if a station being received is weak some hiss may be audible. This hiss can normally be eliminated or reduced by forcing the radio to play the station in mono

1. Press the **Mode button** until the FM waveband is selected.
2. Press the **Menu/Back button**, the main **Menu screen** will be selected.
3. Rotate the **Tuning/Select control** until "Settings" is highlighted on the display. Press and release the **Tuning/Select control**.
4. Rotate the **Tuning/Select control** until "Radio" is highlighted on the display. Press and release the **Tuning/Select control**.
5. Rotate the **Tuning/Select control** until "FM stereo (auto)" is highlighted on the display. Press and release the **Tuning/Select control**.
6. To reduce the hiss rotate the **Tuning/Select control** until "FM mono" is highlighted on the display. Press and release the **Tuning/Select button** your radio will switch to mono mode.
7. To return to stereo mode press and release the **Tuning/Select control** and rotate until the display shows "FM stereo (auto)". Press and release the **Tuning/Select control**.
8. Press the **Menu/back button** or select the "Back..." option to exit.

If you need any further advice, please call our Technical Helpline on :-
020 8758 0338 (Mon-Fri)

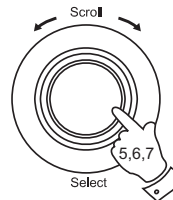
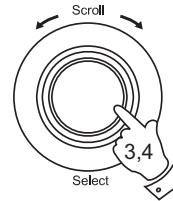
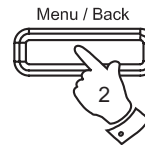
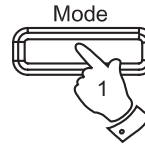

Display settings - Backlight

Enables the backlight to be set to one of the following settings...100%, 50%, 10% and off.

1. Press the **Mode button** until the desired waveband is selected.
2. Press the **Menu/Back button**, the main Menu screen will be selected.
3. Rotate the **Tuning/Select control** until "Settings" is highlighted on the display. Press and release the **Tuning/Select control**.
4. Rotate the **Tuning/Select control** until "Display" is highlighted on the display. Press and release the **Tuning/Select control**.
5. Rotate the **Tuning/Select control** until "Backlight" is highlighted on the display. Press and release the **Tuning/Select control**.
6. To adjust the backlight setting, rotate the **Tuning/Select control** until the required backlight setting is highlighted on the display.
7. Press the **Menu/back button** or select the "Back..." option to exit.

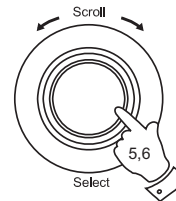
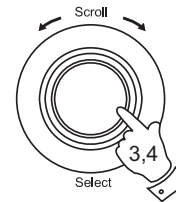
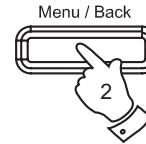
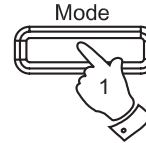

Display settings - Contrast

The display contrast can be changed if needed to suit lighting conditions.

1. Press the **Mode button** until the desired waveband is selected.
2. Press the **Menu/Back button**, the main Menu screen will be selected.
3. Rotate the **Tuning/Select control** until "Settings" is highlighted on the display. Press and release the **Tuning/Select control**.
4. Rotate the **Tuning/Select control** until "Display" is highlighted on the display. Press and release the **Tuning/Select control**.
5. Rotate the **Tuning/Select control** until "Contrast" is highlighted on the display. Press the **Tuning Select control**.
6. To adjust the contrast rotate the **Tuning/Select control**. Press and release the **Tuning/Select control** to confirm selection.
7. The display will return to the previous screen.

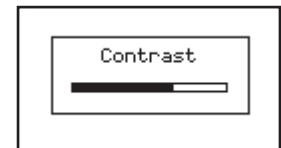
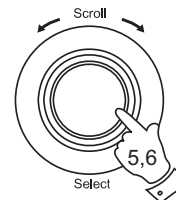
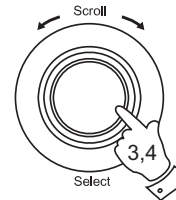
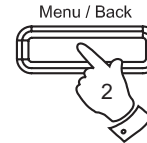
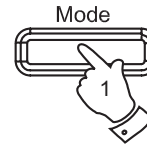

Factory reset

This setting clears all station presets, service list, EPG and returns all variable settings to their factory defaults.

1. Press the **Mode button** until the desired waveband is selected.
2. Press the **Menu/Back button**, the main Menu screen will be selected.
3. Rotate the **Tuning/Select control** until "Settings" is highlighted on the display. Press and release the **Tuning/Select control**.
4. Rotate the **Tuning/Select control** until "Factory reset" is highlighted on the display. Press and release the **Tuning/Select control**.
5. Rotate the **Tuning/Select control** until "FACTORY RESET" is highlighted on the display. Press and release the **Tuning/Select control**.
6. The display will show resetting and after a few seconds your radio will enter DAB autotune.
7. If you do not wish to carry out a factory reset rotate the **Tuning/Select control** until "Back" is selected on the display.
8. The radio will return to the previous screen.

In case of malfunction due to electrostatic discharge, just reset the product (reconnect of power source may be required) to resume normal position.

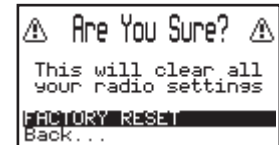
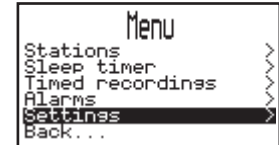
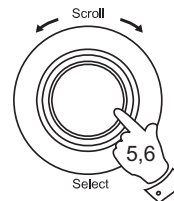
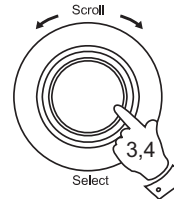
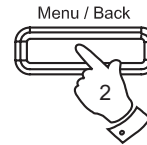
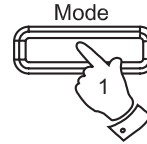

Connecting to an external amplifier or recorder

Your radio has a line-level audio output which you can use to connect your radio to an external amplifier or recorder. This may be a stand-alone unit or it may be part of your existing hi-fi system.

A signal is available from the line output whenever the radio is able to play from the loudspeaker or headphones, regardless of the volume control setting on the radio.

Recording from your radio

Your radio has twelve alarm timers which can be set to switch on your radio at a preset time and day, tuned to a particular station. See the Alarms section for details on how to set timers (page 43).

Note: The timer record function is for personal use only. Your radio is unable to start and stop recordings made by external devices.

Headphone socket

1. A 3.5mm **Headphone Socket** located on the rear of your radio is provided for use with either headphones or an earpiece. Inserting a plug automatically mutes the internal loudspeaker.
2. When in use, the headphone symbol  appears in the display.

IMPORTANT: Excessive sound pressure from earphones and headphones can cause hearing loss.

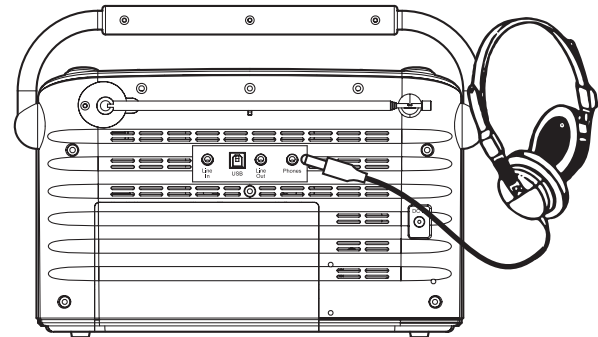
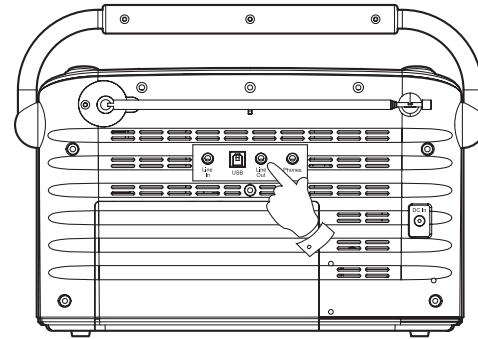

continued on next page

Auxiliary input

Your radio has an auxiliary (line-level) audio input which you can use to allow your radio to be used as an external amplifier for MP3 players, compact disc players and similar devices.

Simply connect the external audio source to the radio's line input socket (on the back of the radio) using a 3.5mm stereo plug. When the plug is inserted the radio display will automatically be blanked. Use the volume and bass and treble controls on your radio to adjust the sound level as needed. Note that you may also need to set the output level on your external device to a higher level than used for normal listening.

Remove the lead from the Line input in order to permit normal operation of your radio.

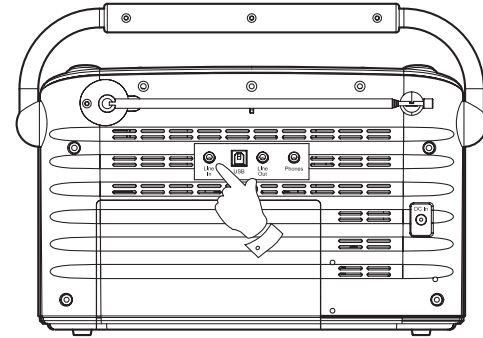

Lock Switch

The **lock switch** located on the under-side of your radio is used to prevent unintentional operation.

1. Slide the Lock switch to the "locked position", the keylock symbol  will appear in the display. The Power/Standby and all other buttons will be disabled. This will prevent accidental operation when the radio is packed in a suitcase. To release the Lock switch move the switch to the "unlocked position", the keylock symbol will be removed from the display.

Standby display

When your radio is in standby mode the time and date will be displayed and the radio will check all available DAB stations for EPG information.

1. If your radio is mains operated and switched on, press and release the **Power/Standby button** to switch your clock radio to standby mode.



USB connection

Your radio has a USB connection to connect your PC. The usb can be used to copy files to and from your SD card and also for any software updates available.

When the USB connection is used to link your radio to your PC the SD card should appear as a removable disk drive. Radio recordings are held in a folder called "RADIO". MP3 and WMA files may be stored in other folders which you may create.

If your PC already has an SD card reader, you will find that file transfer is faster when using this than when using the USB connection to your radio.

Your radio uses the FAT 16 format for storing files on the SD card.

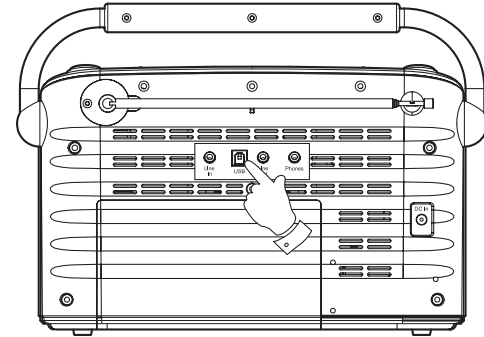

General

Do not allow this radio to be exposed to water, steam or sand. Do not leave your radio where excessive heat could cause damage. It is recommended that the DAB band be used wherever possible as better results in terms of quality and freedom from interference will usually be obtained than on the FM band.

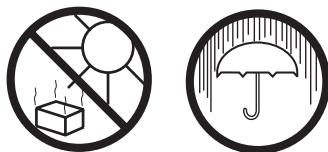

IMPORTANT

- The radio shall not be exposed to dripping or splashing and that no objects filled with liquids, such as vases, shall be placed on the radio.
- It is recommended to operate the product such that there is a minimum distance (10cm recommended) to adjacent objects in order to ensure good ventilation.
- The ventilation of the product should not be restricted by covering it or its ventilation openings with items such as newspapers, tablecloths, curtains etc.
- No naked flame sources such as lighted candles should be placed on the product.
- It is recommended to avoid using or storing the product at extremes of temperature. Avoid leaving the unit in cars, on window sills in direct sunlight etc.
- The radio must be used in a moderate climate.

Specifications

AC	230V \sim 50Hz via adaptor.
Batteries	6 x IEC size LR20 (D size)
Battery Life	Approx. 50hrs of listening when used for 4 hours a day at normal volume using alkaline batteries. (PausePlus storage and Backlight off)
Frequency Coverage	FM 87.5 - 108MHz DAB 174.928 - 239.200MHz

Circuit Features

Loudspeaker	2 x 79mm diameter 4ohms
Output Power	3 Watts max
Headphone socket	3.5mm dia stereo
Line output	3.5mm dia stereo
Line input	3.5mm dia stereo
Aerial System	FM Telescopic aerial DAB Telescopic aerial

The Company reserves the right to amend the specification without notice.

Guarantee

This instrument is guaranteed for twelve months from the date of delivery to the original owner against failure due to faulty workmanship or component breakdown, subject to the procedure stated below. Should any component or part fail during this guarantee period it will be repaired or replaced free of charge.

The guarantee does not cover:

1. Damage resulting from incorrect use.
2. Consequential damage.
3. Receivers with removed or defaced serial numbers.

N.B. Damaged or broken telescopic aerials will not be replaced under guarantee.

Procedure:

Any claim under this guarantee should be made through the dealer from whom the instrument was purchased. It is likely that your Roberts' dealer will be able to attend to any defect quickly and efficiently but should it be necessary the dealer will return the instrument to the Company's service department for attention. In the event that it is not possible to return the instrument to the Roberts' dealer from whom it was purchased, please contact Roberts Radio Technical Services at the address shown on the rear of this manual.

These statements do not affect the statutory rights of a consumer.

ROBERTS RADIO TECHNICAL SERVICES

97-99 Worton Road

Isleworth Middlesex

TW7 6EG

Technical Helpline :- 020 8758 0338 (*Mon-Fri during office hours*)

Website: <http://www.robertsradio.co.uk>

